

ZQ511/ZQ521

Mobile Printers



User Guide



ZEBRA

ZEBRA and the stylized Zebra head are trademarks of Zebra Technologies Corporation, registered in many jurisdictions worldwide. All other trademarks are the property of their respective owners.
© 2023 Zebra Technologies Corporation and/or its affiliates. All rights reserved.

Information in this document is subject to change without notice. The software described in this document is furnished under a license agreement or nondisclosure agreement. The software may be used or copied only in accordance with the terms of those agreements.

For further information regarding legal and proprietary statements, please go to:

SOFTWARE: zebra.com/linkoslegal

COPYRIGHTS: zebra.com/copyright

PATENTS: ip.zebra.com

WARRANTY: zebra.com/warranty

END USER LICENSE AGREEMENT: zebra.com/eula

Terms of Use

Proprietary Statement

This manual contains proprietary information of Zebra Technologies Corporation and its subsidiaries (“Zebra Technologies”). It is intended solely for the information and use of parties operating and maintaining the equipment described herein. Such proprietary information may not be used, reproduced, or disclosed to any other parties for any other purpose without the express, written permission of Zebra Technologies.

Product Improvements

Continuous improvement of products is a policy of Zebra Technologies. All specifications and designs are subject to change without notice.

Liability Disclaimer

Zebra Technologies takes steps to ensure that its published Engineering specifications and manuals are correct; however, errors do occur. Zebra Technologies reserves the right to correct any such errors and disclaims liability resulting therefrom.

Limitation of Liability

In no event shall Zebra Technologies or anyone else involved in the creation, production, or delivery of the accompanying product (including hardware and software) be liable for any damages whatsoever (including, without limitation, consequential damages including loss of business profits, business interruption, or loss of business information) arising out of the use of, the results of use of, or inability to use such product, even if Zebra Technologies has been advised of the possibility of such damages. Some jurisdictions do not allow the exclusion or limitation of incidental or consequential damages, so the above limitation or exclusion may not apply to you.

“Made for iPod”, “Made for iPhone”, and “Made for iPad” mean that an electronic accessory has been designed to connect specifically to iPod, iPhone, or iPad, respectively, and has been certified by the developer to meet Apple performance standards. Apple is not responsible for the operation of this device or its compliance with safety and regulatory standards. Please note that the use of this accessory with iPod, iPhone, or iPad may affect wireless performance.

Bluetooth® is a registered trademark of the Bluetooth SIG.

© 1996–2009, QNX Software Systems GmbH & Co. KG. All rights reserved. Published under license by QNX Software Systems Co.

Certified by:



Publication Date

March 30, 2023

Contents

About This Document	8
Introduction	8
Configurations	8
Related Documents and Software	8
Service Information	8
Printer Overview	10
Unpacking and Inspection.....	11
Reporting Damage	11
Technology.....	12
PowerPrecision+ (PP+) Battery	12
Printing Technology	13
Product Information QR Code.....	13
Made for iPhone (MFi)	13
Near Field Communication (NFC).....	14
Thermal Shutdown	14
Radio-Frequency Identification (RFID).....	14
Printer Features	15
Using the Printer	17
Preparing the Battery for Use.....	17
Installing/Removing Battery and Battery Tape Insulator	17
Removing the Battery.....	17
Removing the Battery Tape Insulator.....	18
Battery Safety	19
Charging the Battery.....	21
AC Power Adapter	21
Vehicle Cradle	22
Battery Eliminator/Battery Eliminator Vehicle Cradle	22
4-Bay Power Station.....	22

1-Slot Battery Charger	23
Use Case: Home Office/Small Business	23
3-Slot Battery Charger/Dual 3-Slot Battery Charger	25
Use Case: Settlement Room	25
Vehicle Adapter	25
Use Case: Vehicle	25
Loading Media	26
Operator Controls	28
Printer Status Icons	29
Buttons	30
Power Up Sequences	30
Run Time Sequences without LED Flashes	30
LEDs	30
Alerts	31
Power Saving Features	31
Sleep Mode	31
Adaptive Print Performance	32
Draft Mode	32
Verify That the Printer is Working	32
Printing a Configuration Report	32
Connecting the Printer	33
Cable Communication	33
Zebra Setup Utilities	34
Zebra Android Printer Setup Utility (for Link-OS Printers)	35
Wireless Communications with Bluetooth	36
Bluetooth Networking Overview	36
Bluetooth (BT) Security Modes	37
Bluetooth Minimum Security Modes	38
WLAN Overview	39
Setting Up the Software	39
Designing Labels	40
Using Pre-Printed Receipt Media	41
Black Mark Dimensions (Receipt Media)	41
Label Areas	41
Label Design Examples	42
Keep-Out Areas	43
Near Field Communication (NFC)	43
NFC Use Cases	44
Passive	44
Wearing the Printer	45
Swivel Belt Clip	45
Shoulder Strap	46

Contents

Soft Case	46
Exoskeleton	47
Preventive Maintenance.....	48
Extending Battery Life	48
General Cleaning Instructions	48
Troubleshooting	51
Front Control Panel.....	51
Printer Status Indicators.....	51
Troubleshooting Topics.....	52
No power	52
Media does not feed.....	53
Poor or faded print.....	53
Partial or missing print.....	53
Garbled print.....	53
No print	53
Reduced battery charge life.....	53
Data icon flashing	53
Media or Cover Open icons flashing	54
Communication error	54
Label binding	54
Blank LCD screen.....	54
No NFC Connectivity	54
Troubleshooting Tests.....	54
Printing a Configuration Report	54
Communications Diagnostics	55
Contacting Technical Support.....	56
Specifications	57
Printing Specifications.....	57
Memory and Communications Specifications	57
Label Specifications	58
CPCL Font and Bar Code Specifications and Commands.....	59
ZPL Font and Bar Code Specifications and Commands.....	60
Communication Port.....	61
USB	61
Physical, Environmental and Electrical Specifications.....	61
Accessories.....	64

Miscellaneous	65
Serial Number and PCC Number Locations	65
Cables	66
USB Cables	66
Media Supplies.....	68
Maintenance Supplies.....	68
Battery Disposal	69
Product Disposal	69
Alert Messages	70

About This Document

Introduction

This guide provides information about using the ZQ511 and ZQ521 mobile printers and accessories.

Configurations

This guide covers the following configurations:

Configuration	Operating System	Radios	Display	Memory
ZQ511	LINK-OS	802.11ac/BT 4.1 Dual	Color LCD	512 MB
ZQ521	LINK-OS	802.11ac/BT 4.1 Dual	Color LCD	512 MB

Related Documents and Software

The following documents provide more information about the ZQ500 Series mobile printers.

- ZQ511/ZQ521 Quick Start Guide

For the latest version of this guide and all guides, go to zebra.com/support.

Service Information



If you have a problem with your equipment, contact Zebra Global Customer Support for your region. Contact information is available at zebra.com/support.

When contacting support, please have the following information available:

- Serial number of the unit
- Model number or product name
- Software/firmware type or version number

Zebra responds to calls by email, telephone or fax within the time limits set forth in support agreements.

About This Document

If your problem cannot be solved by Zebra Customer Support, you may need to return your equipment for servicing and will be given specific directions. Zebra is not responsible for any damages incurred during shipment if the approved shipping container is not used. Shipping the units improperly can possibly void the warranty.

If you purchased your Zebra business product from a Zebra business partner, contact that business partner for support.

Printer Overview

This user guide provides the information to operate the Zebra ZQ511 and ZQ521 printers. The printers use some of the latest technologies such as an 802.11ac/Bluetooth 4.1 dual radio, a smart battery with PowerPrecision+ functionality, Near Field Communication (NFC), a color LCD display and Made for iPhone® (MFi). MFi printers provide Apple co-processor (MFi) support which allows an Apple device such as an iPhone or iPad to authenticate and connect over Bluetooth.



These printers use CPCL and ZPL programming languages to configure the printers and print properties, label design, and communications. See the Zebra Programming Guide at zebra.com/manuals for more information.

Software Resources and Utilities:

- ZebraNet Bridge Enterprise™: printer configuration, fleet management
- Zebra Setup Utility: single printer configuration, quick setup
- Zebra Mobile Setup Utility: Android-based setup tool
- ZebraDesigner Pro v2: label design
- Zebra Designer Drivers: Windows® driver
- OPOS Driver: Windows driver
- Multiplatform SDK
- Zebra Downloader
- Printer Profile Manager Enterprise (PPME). These utilities can be found on the Zebra website at zebra.com/us/en/support-downloads.

Unpacking and Inspection

In case shipping is required, save the carton and all packing material.

1. Open box and make sure it includes the following materials: Printer, Quick Start Guide, Regulatory Guide, Safety Guide, battery, and belt clip.



2. Check all exterior surfaces of the product components for damage.
3. Open the media cover (refer to [Loading Media on page 26](#)) and inspect the media compartment for damage.

Reporting Damage

If you discover shipping damage:

- Immediately notify and file a damage report with the shipping company. Zebra Technologies Corporation is not responsible for any damage incurred during shipment of the printer and will not cover the repair of this damage under its warranty policy.
- Keep the carton and all packing material for inspection.
- Notify your authorized Zebra reseller.

Technology

The printers use several technologies made popular in other mobile printer product lines, as well as newer, state-of-the-art technologies.

PowerPrecision+ (PP+) Battery



The printers use a 2-cell Li-ion battery pack with integrated intelligence and data storage capability meeting PowerPrecision+ (PP+) functionality. This intelligent battery has the integrated technology required to collect the detailed real-time battery metrics needed to maximize useful battery life and ensure every battery is healthy and able to hold a full charge. In addition, technology inside the batteries tracks and maintains the metrics required to provide real-time visibility into more meaningful battery statistics, such as total cycle usage of the battery, whether the battery is old and should be retired or how long a battery will take to fully charge.

Operating Temperature	Charging Temperature	Storage Temperature
-20°C to +50°C (-4°F to 122°F)	0°C to +40°C (32°F to 104°F)	-25°C to +60°C (-13°F to 140°F)



IMPORTANT: The printers only function properly with genuine Zebra PP+ battery packs. The printers also use an extended 4-cell smart battery with higher capacity and stronger security.

To achieve the best fast charging results, charge batteries at room temperature with the device powered off. Ideal charging conditions are within temperatures from 5°C to 40°C (41°F to 104°F). The device always performs battery charging in a safe and intelligent manner. At higher temperatures, the device may for small periods of time alternately enable and disable battery charging to keep the battery at acceptable temperatures. Under abnormal temperatures the device will indicate when charging is unable to be initiated via its LED and a notification that appears on the display.

The smart battery's health has three states: Good, Replace, and Poor. The battery health factor determines whether or not the printer can operate and what is communicated to the user via the display.

# of Charge Cycles	Health	Power-up Message
<300	GOOD	None
≥ 300 but <550	REPLACE	Battery Diminished Consider Replacing ^a
≥ 550 but <600	REPLACE	Warning-Battery Is Past Useful Life
≥ 600	POOR	Replace Battery Shutting Down ^b

a. Warning accompanied by one long beep.

b. Warning will flash on and off accompanied by beeping at a rate of once per second. After 30 seconds, the printer will shut down.



NOTE: Power down the printer before removing the battery to minimize the risk of corruption.

Printing Technology

The printers use the Direct Thermal method to print human readable text, graphics, and barcodes. It incorporates a sophisticated print engine for optimal printing under all operational conditions. Direct thermal printing uses heat to cause a chemical reaction on specially treated media. This reaction creates a dark mark wherever a heated element on the printhead comes in contact with the media. Since the printing elements are arranged very densely at 203 d.p.i. (dots per inch) horizontal and 200 d.p.i. vertical, highly legible characters and graphic elements may be created a row at a time as the media is advanced past the printhead. This technology has the advantage of simplicity, as there is no requirement for consumable supplies such as ink or toner. However, since the media is sensitive to heat, it will gradually lose legibility over long periods of time, especially if exposed to environments with relatively high temperatures or in direct sunlight.

Product Information QR Code

The QR barcode includes human readable text URL, for example zebra.com/ZQ511-info, which links the user to printer information and videos on topics such as buying supplies, features overview, loading media, printing a configuration report, cleaning instructions, and accessory information.

Figure 1 QR Code (ZQ511 Shown)



Made for iPhone (MFi)

The printers support communication with Apple devices running iOS 10 or later over a standalone Bluetooth 4.1 radio and the BT4.1 radio included with the 802.11ac (dual) radio.



Near Field Communication (NFC)

The printers support a passive NFC tag which complies with the Android Standard Tag format since Android devices are the most common found on the market today. The NFC tag is programmed from the factory and supports Bluetooth pairing to enable a tablet, smartphone or mobile computer to automatically pair with the printer via a Bluetooth connection (within the bounds of the security profile being used).

The NFC tag also supports app launching whereby an app developed either by Zebra or a third party will launch on a NFC-enabled smartphone, tablet or mobile computer. Similarly, the NFC tag enables launching to a web support page via a tablet, smartphone or mobile computer.

Thermal Shutdown

The printers have a thermal shutdown feature whereby the printer hardware will detect a printhead over-temperature condition at 65°C (149°F). The printer automatically stops printing until the printhead cools down to 60°C (140°F). Printing then recommences without a loss of label data or without any degradation of print quality.

Radio-Frequency Identification (RFID)

The printers are equipped with an RFID encoder/reader, which is integrated into the printer's printhead assembly. The printers encode (write) information on ultra-thin UHF RFID transponders that are embedded in "smart" labels, tickets, and tags. The printers encode the information; verify proper encoding; and print bar codes, graphics, and/or text on the label's surface. The printers use Zebra's extensive set of RFID commands running under ZPL programming language.

The RFID transponder is sometimes called the RFID tag or an inlay. The transponder is usually made of an antenna that is bonded to an integrated circuit (IC) chip. The IC chip contains the RF circuit, coders, decoders, and memory. If you hold an RFID label up to the light, you can see the transponder's antenna, and you can feel a bump in the label where the IC chip is located. The printers can encode and verify EPC (Electronic Product Code) Generation 2 Class 1 UHF passive RFID tags, in addition to printing human readable text and conventional 1-D and 2-D barcode information on Zebra supplied RFID thermal transfer media. EPC is a product numbering standard that can be used to identify a variety of items by using RFID technology. EPC Generation 2 tags offer advantages over other tag types. The tag identification (TID) memory in a Generation 2 tag includes the chip manufacturer and model number information, which can be used to identify which optional features are present on the tag. These optional features include those for data content and security.

Gen 2 tags typically have a 96-bit EPC identifier, which is different from the 64-bit identifiers common in early EPC tags. The 96-bit EPC code links to an online database, providing a secure way of sharing product-specific information along the supply chain. Gen 2 tags also support much larger data structures. The size of user memory available (if any) varies by the model and manufacturer of the tag.

Encoding and printing of an RFID label usually are completed on the first try, but some failures may occur. If you experience consistent encoding failures, it may signal a problem with the RFID tags, your label formats, or with the transponder placement. If an RFID tag cannot be encoded, "VOID" will be printed on the label. The printer then attempts to read/encode "n" labels before the next format is attempted, where "n" is specified by the ZPL programming language "^RS" command. Acceptable values of "n" are 1 to 10 and the default is 3. After printing the defined number of voided RFID labels, the printer default is No Action (Label format causing the error is dropped).

While the user doesn't have control of where on the label the VOID is printed, they can control the length of the image. The start of the VOID image is always at the program position (or F0 if a backward program position). More information on the "^RS" command may be found in the RFID Programming Guide 3 available on zebra.com/manuals.

RFID is an optional feature and is a factory-installed option only.



NOTE: Refer to zebra.com/warranty for complete information on product warranties.

Printer Features

Figure 2 Overview of Features (ZQ511 Shown).

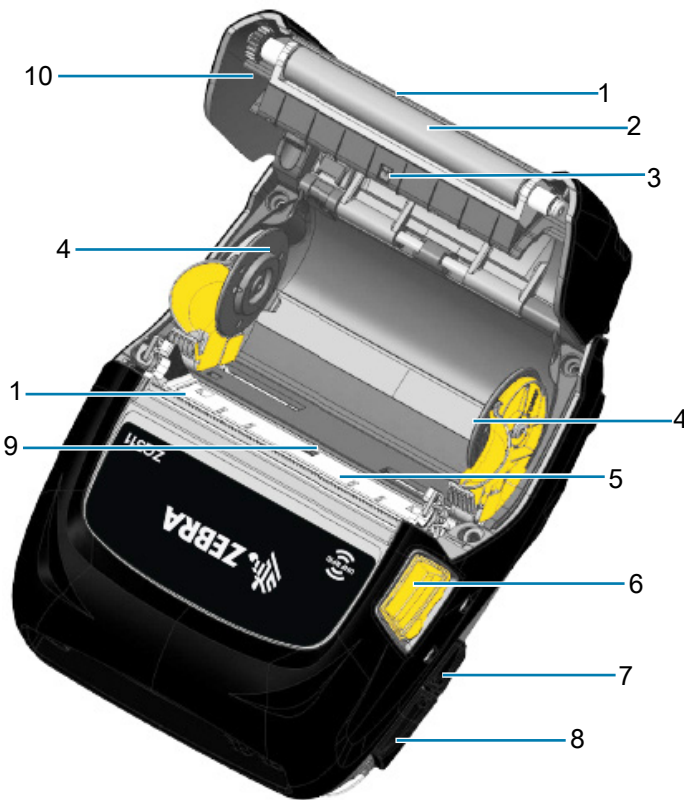

1	Tear bar (Not present in Linerless. Scraper present instead.)
2	Platen roller
3	Black bar sensor
4	Media support disks
5	Printhead

6	Latch release button
7	DC input
8	USB port
9	Gap sensor
10	Media cover



NOTE: Scanning the QR code with a mobile device will provide printer-specific information at zebra.com/ZQ511-info and zebra.com/ZQ521-info.



NOTE: Tapping the Zebra Print Touch™ icon with a Near Field Communication (NFC) enabled mobile device will provide instant access to printer-specific information. For more information about NFC and Zebra products, go to zebra.com/nfc. Bluetooth pairing applications via NFC is also possible. Please see Zebra Multi-platform SDK for more information.

Figure 3 Printer Front Features

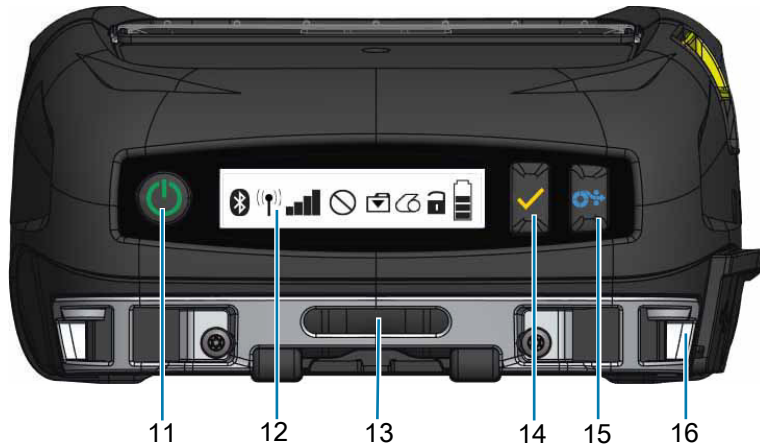

11	Power button	14	Select button
12	Control panel	15	Paper feed button
13	Belt clip opening	16	Strap post

Figure 4 Printer Bottom Features

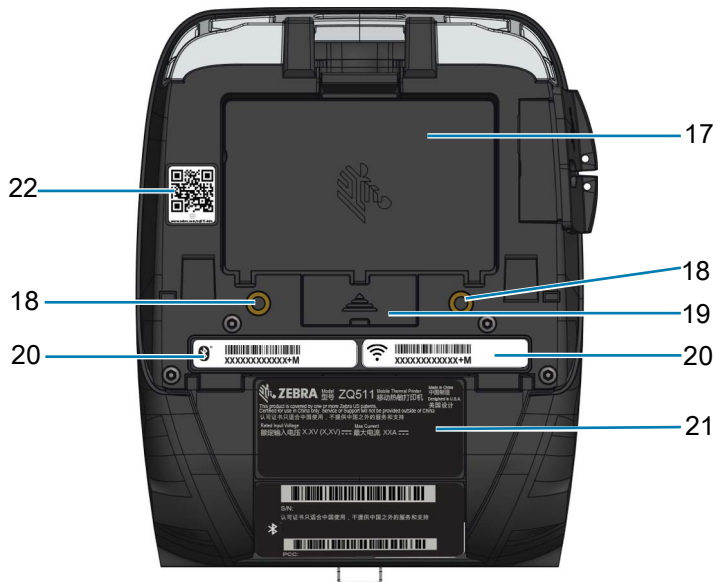

17	Battery	20	MAC address/Bluetooth ID
18	Mounting points	21	Serial labels
19	Docking contacts cover	22	QR code

Using the Printer

Preparing the Battery for Use

Installing/Removing Battery and Battery Tape Insulator



IMPORTANT: Batteries are shipped in sleep mode to preserve their maximum capacity while in storage prior to initial use. The battery needs an initial charging to wake it up before using for the first time. (See [Charging the Battery on page 21](#))

Removing the Battery

1. If a belt clip is present on the bottom of the printer, rotate it such that it provides clearance for the battery.
2. Depress the latch on the battery pack ([Figure 5](#)).

Figure 5 Battery Latch



3. Rotate the battery pack forward and lift it up and out of the battery well (Figure 6).

Figure 6 Removing Battery



Removing the Battery Tape Insulator



CAUTION: The battery can explode, leak or catch fire if improperly charged or exposed to high temperature. Do not disassemble, crush, puncture, short external contacts or dispose of in fire or water. Charge on a Zebra approved Lithium-Ion charger only.

1. Pull up on the tape insulator tab located on the bottom of the battery pack.
2. Peel back the tape insulator and remove it from the top of the battery pack. Discard upon removal.

Figure 7 Removing Battery Tape Insulator

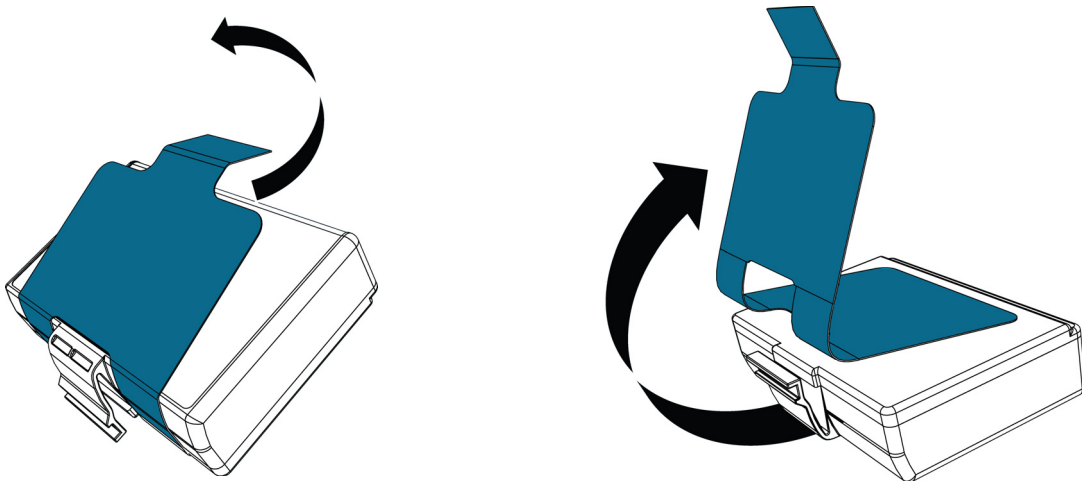

Battery Safety



CAUTION: Avoid accidental short circuiting of any battery. Allowing battery terminals to contact conductive material will create a short circuit which could cause burns and other injuries or could start a fire.



IMPORTANT: Always refer to the Important Safety Information data sheet shipped with each printer and the Technical Bulletin shipped with each battery pack. These documents detail procedures to ensure maximum reliability and safety while using this printer.



IMPORTANT: Always dispose of used batteries properly. Refer to [Product Disposal on page 69](#) for more battery recycling information.



CAUTION: Use of any charger not approved specifically by Zebra for use with its batteries could cause damage to the battery pack or the printer and will void the warranty.



CAUTION: Do not incinerate, disassemble, short circuit, or expose to temperatures higher than 65°C (149°F).

Installing the Battery

1. Locate the battery compartment on the bottom of the printer (Figure 8).
2. Swivel the belt clip (if present) to access the battery compartment.

Figure 8 Battery Compartment



3. Insert the battery into the printer as shown. (It is not possible to insert the pack in the incorrect orientation.)

Figure 9 Battery Insertion



4. Rotate the battery into the compartment until it locks in place and is sitting flush in the printer.

Figure 10 Battery Installed



Charging the Battery



CAUTION: Do not place any charger in locations where liquids or metallic objects may be dropped into the charging bays.

AC Power Adapter

Figure 11 AC Power Adapter Charging

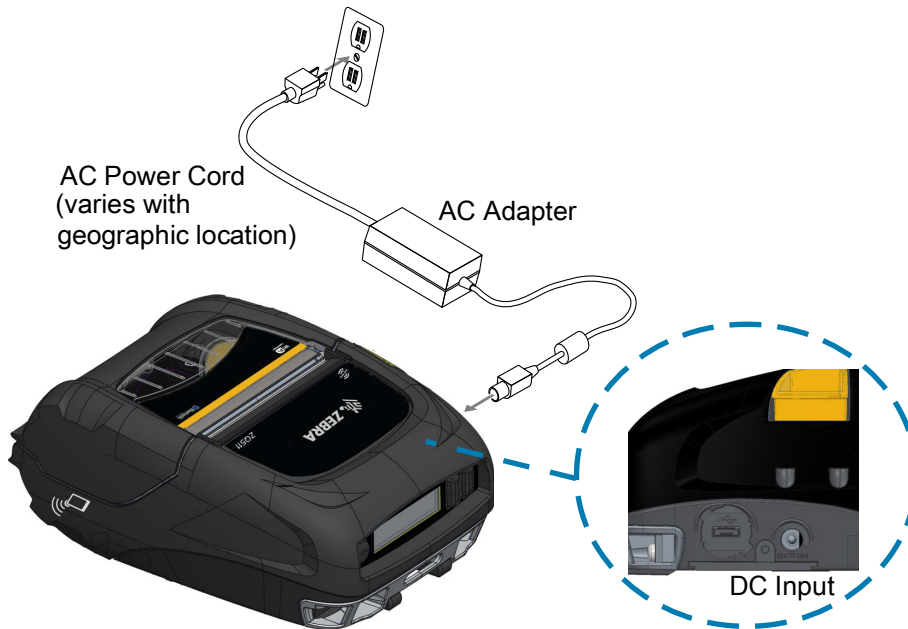

1. Open the protective cover on the printer to expose the DC input charger jack.
2. Connect the appropriate AC power cord for your location to the adapter and then plug the power cord into an AC receptacle.
3. Plug the barrel plug from the AC adapter into the charger jack on the printer.
4. The printer powers up and begins charging. The printer can be left on or turned off at this point. Charging continues in either state.



IMPORTANT: While it is possible to charge the battery when using the printer, charge times will increase under this condition.

Vehicle Cradle

The Vehicle Cradle provides a means to mount a printer in a vehicle while at the same time providing charging power to the battery. The Vehicle Cradle features USB connectivity to allow the user to connect a laptop or tablet to the cradle.

Figure 12 Vehicle Cradle

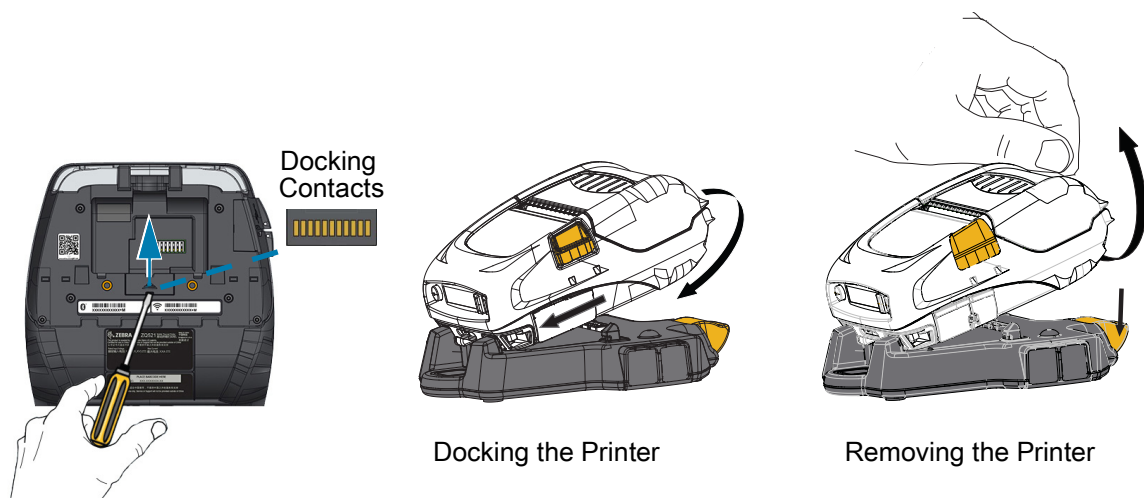

Battery Eliminator/Battery Eliminator Vehicle Cradle

The Battery Eliminator Vehicle Cradle enables the user to mount a ZQ511 or ZQ521 printer in a vehicle without the use of a battery.

4-Bay Power Station

The 4-Bay Power Station allows a total of four printers to be docked and charged. The Power Station provides battery charging power while still maintaining all of the printer's functionality.



NOTE: For detailed information on accessories, refer to the ZQ500 Series VC User Guide, the ZQ500 Series 4-Bay Power Station User Guide, the Battery Eliminator User Guide, and the Battery Eliminator Cradle User Guide at zebra.com/manuals.

Before docking the printer on either the Vehicle Cradle or the 4-Bay Power Station, you must remove the docking contacts cover located on the bottom of the printer. To remove the cover, first remove the battery, and then use a small screwdriver or coin to detach the cover and expose the docking contacts.

Figure 13 4-Bay Power Station

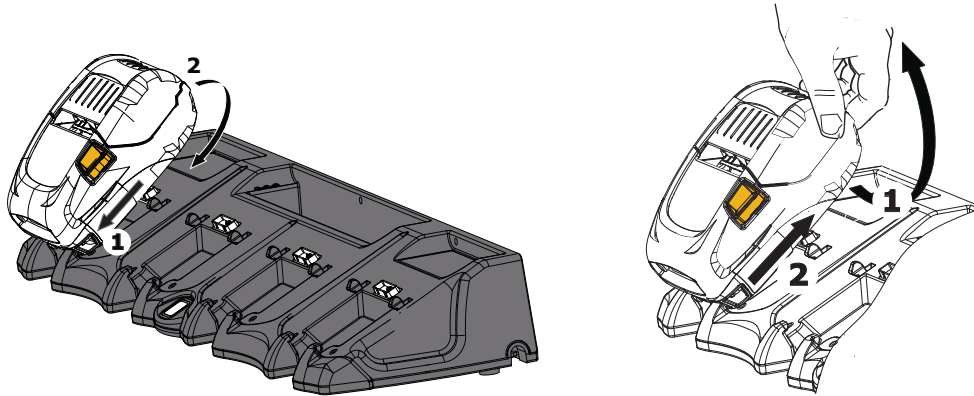

1-Slot Battery Charger

Use Case: Home Office/Small Business





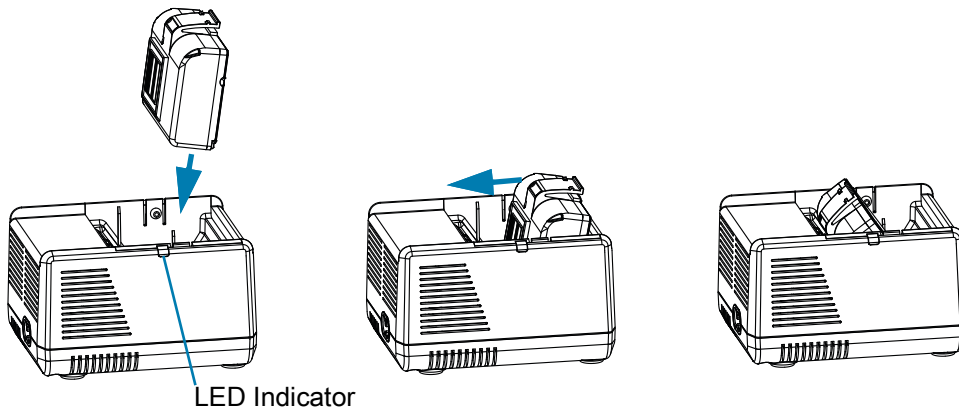

The 1-Slot Battery Charger provides the user with a single, spare battery charging solution. Similar to the 3-Slot Battery Charger, the single charger charges a 2-cell battery from empty to fully charged in less than four hours and a 4-cell battery from empty to fully charged in less than six hours.

Figure 14 1-Slot Battery Charger



Charging Status Indicators

Both the 3-slot and 1-slot battery chargers use an LED indicator located next to each slot to indicate the charge state in either green, red, or amber as detailed below.

Mode	Charging Indication	Description
Charge Fault		Fast Blinking Red
Charging (Healthy)		Solid Amber
Charge Done (Healthy)		Solid Green
Charging (Unhealthy)		Solid Red
Charging Done (Unhealthy)		Solid Red
Best Battery (Charging)		Alternates between solid and bright bursts of amber
Best Battery (Charge Done)		Alternates between solid and bright bursts of green

3-Slot Battery Charger/Dual 3-Slot Battery Charger

Use Case: Settlement Room

The 3-Slot Battery Charger is a charging system for use with the 2-cell lithium-ion batteries used in the printers. The 3-slot charger is capable of charging three 2-cell batteries simultaneously from empty to full in less than four hours and 4-cell batteries from empty to fully charged in less than six hours. It can either be used as a standalone charger or mounted on a 5-slot shared cradle.

Figure 15 3-Slot Battery Charger

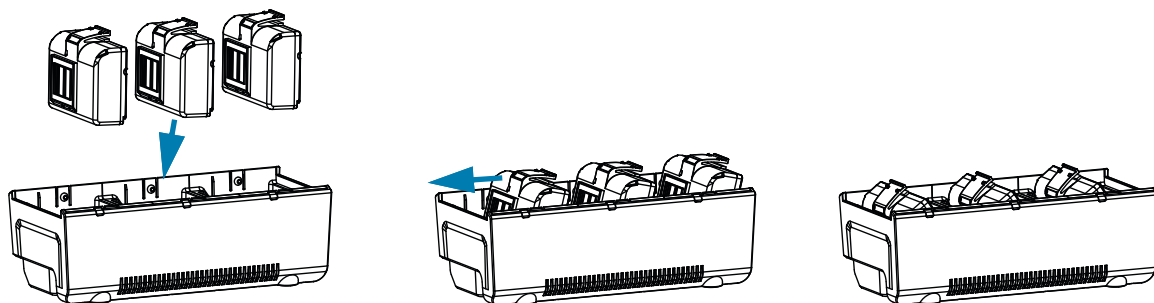

Vehicle Adapter

Use Case: Vehicle

The printers, along with accompanying Zebra TC51/TC56 mobile computers, can be charged in the vehicle through the use of a Vehicle Adapter. The Vehicle Adapter uses either an open-ended connection or cigarette lighter adapter, along with a power supply.

Figure 16 Vehicle Adapters

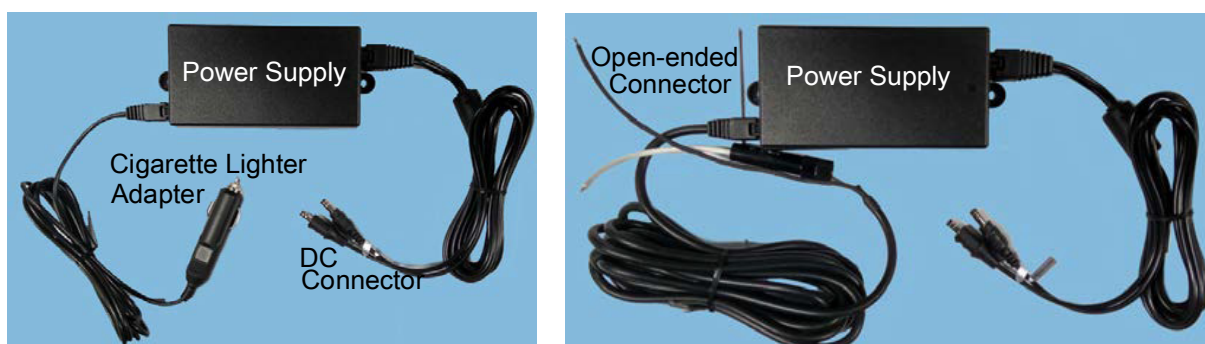

Loading Media

The printers are designed to print either continuous (receipt) media or label stock.

1. Press the media cover button on the side of the printer. The media cover opens automatically.

Figure 17 Media Cover Button



2. Rotate the media cover back completely, exposing the media compartment and adjustable media supports.

Figure 18 Opening the Media Cover

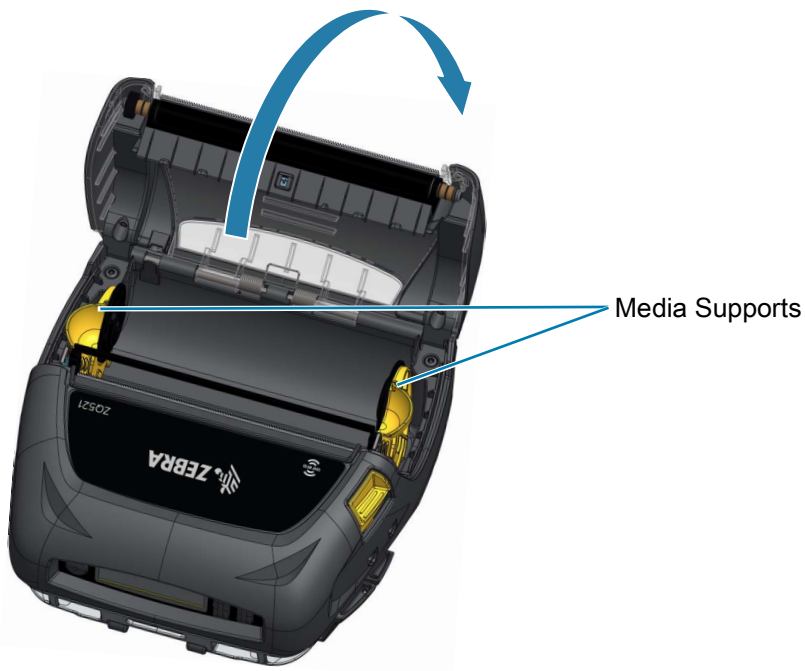

3. Pull the media supports apart as shown in [Figure 19](#). When you move one support, both supports will move.
4. Insert the roll of media between the supports in the orientation shown, and let the supports secure the media in place. The media roll should be able to spin freely on the supports.

Figure 19 Loading Media



5. Close the media cover until it clicks into place and the media advances.

Figure 20 Closing the Media Cover



NOTE: Refer to the Zebra Programming Guide for information about adjusting the media feed length via a Set/Get/Do (SGD) command.

Operator Controls





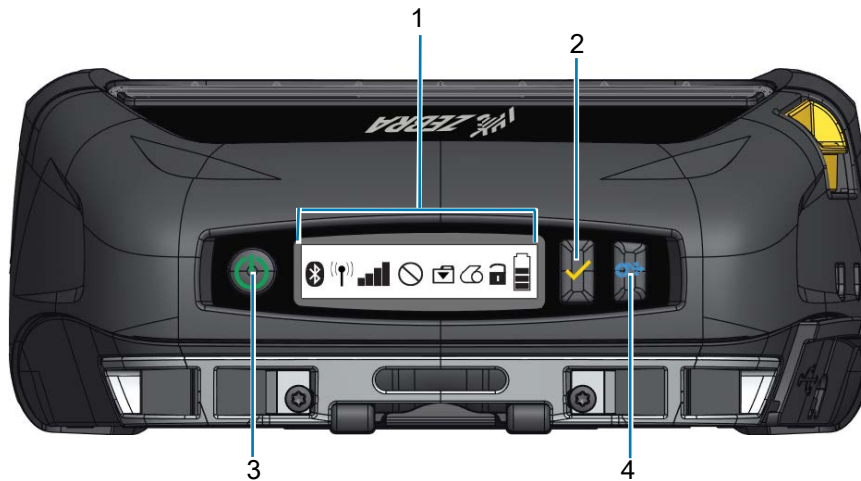





The printers feature a control panel with buttons for the Power On/Off and Media Feed functions, as well as a display for providing information regarding printer functions. The menu displays a single row of icons used to indicate printer status. The LCD also displays acknowledged alerts and unacknowledged alerts. Acknowledged alerts have a single response option which requires the user to press the Select button, whereas unacknowledged alerts do not require a response.

Figure 21 Control Panel



1	Printer Status Icons - Indicates the status of several printer functions.
2	Select Button - Press to select a menu choice on the LCD.
3	Power Button - Press to turn unit on. Press again to turn unit off.
4	Paper Feed Button - Press to advance the media one blank label or a software determined length of journal media.

Printer Status Icons

Icon	Description	Icon	Description
	Bluetooth		Media
	WiFi Connection		Cover Open
	WiFi Signal Strength		Battery
	Error		Battery Eliminator
	Data		Power Save Mode
	Draft Mode		

When the printer is in Power Save Mode and is not in a media out condition, the Power Save icon displays. When the printer is in Power Save Mode and also in a media out condition, the blinking Media Out icon displays instead of the Power Save icon. This is because the printer is not running when there is a media out condition. If the printer is in both Power Save Mode and Draft Mode, the Power Save icon displays.

When the printer is in Draft Mode due to a user setting, the Draft Mode icon will be displayed. However, when the printer is in Draft Mode and in a media out condition, the blinking Media Out icon will be displayed.

For more detailed information on the printer status icons, see [Printer Status Indicators on page 51](#)

Buttons

The user has the ability to use the three button interface on the printers with the following Power Up and Run Time sequences.

Power Up Sequences

Sequence #	Function	Keys
1	Print configuration report	Hold down Feed button while pressing the Power button.
2	Print configuration report then network report	Hold down Select button while pressing the Power button.
3	Initiate forced download	Hold down the Select and Feed buttons while pressing the Power button.
4	Turn the printer on or off or to enter Sleep Mode	Power Button







NOTE: A forced download is when the printer is powered up in a mode where it is running only the code that allows for firmware downloads to happen.

Run Time Sequences without LED Flashes

Sequence #	Function	Keys
1	Two-key and ZPL Config	Hold down Feed button and Select button for 3 seconds.
2	Repeated Feed Events	Feed button
3	Wake (if in Sleep Mode)	Power button or Select button

LEDs

The printers feature a tri-colored LED ring located around the Power button which indicates the state of the battery during charging process.

Icon Behavior	State of Battery
	Power On/Charged Battery Power On/Battery Eliminator Plugged In
	Battery Charging (Amber LED Ring)
	Sleep Mode and Charging (Blinking Amber LED Ring)
	Sleep Mode (Blinking Green LED Ring)
	Battery Fault (Red LED Ring)

Alerts

The control panel displays various alerts to the user in the form of Acknowledged Alerts, Unacknowledged Alerts, and Error Alerts. An Acknowledged Alert displays over the printer status icons and requires user input to be cleared, i.e. press the Select button to clear such an alert.

Figure 22 Control Panel

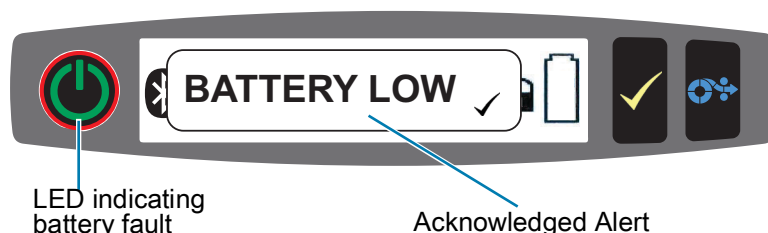

An Unacknowledged Alert also displays over the printer status icons, but in this case it does not require user input to be cleared. The alert will automatically be cleared after being displayed for five seconds.

Error Alerts also appear over the printer status icons and require no user input via the front panel to be cleared, but they do require the user clearing the error condition by other means. The Error Alert will remain on the display until the error condition is cleared.

Power Saving Features

The printers have a few key features designed to extend the life of the battery. These features are described below.

Sleep Mode

The Sleep Mode feature is a way the printer conserves battery life whereby the printer will automatically go into a “sleep” state after two minutes of inactivity. When the printer is in this state there will be no content displayed on the LCD in addition to no backlight. The printer will indicate Sleep Mode by a slow blinking green LED ring around the Power Button (see [LEDs on page 30](#)).

- If the Power Button is pressed for less than three seconds (<3), then the printer will enter Sleep Mode.
- If the Power Button is pressed for more than three seconds (>3), then the printer will power down completely.

In order to “wake up” the printer, the user must press the Power or Select <icon> buttons for less than three seconds, or the printer will wake up on its own when communication is initiated via Bluetooth.

The printers will also wake from Sleep Mode when communication is initiated via WLAN. If the Power Button is pressed for more than three seconds, the printer will wake up and shut down completely.

To enable or disable Sleep Mode, send the `power.sleep.enable` command to the printer using Zebra Setup Utilities (ZSU) and set it to either "on" or "off". (The default setting is "on".) To set the time after which the printer will enter Sleep Mode, send the `power.sleep.timeout` (in seconds) to the printer using the ZSU.

Adaptive Print Performance

The printers use PSPT PrintSmart Gen 2 technology which adapts to your print conditions such that print quality is not sacrificed. When the printer sees environmental conditions such as state of charge, battery health, cold temperature extremes, or high density printing, the printer will adjust print performance to preserve battery function and allow printing to continue. This may affect the speed and sound of printing but not the print quality.

Draft Mode

The user can configure the printer to print in Draft Mode via SGD command `media.draft_mode` (default is "off"), which optimizes the printer for text-only printing. While in Draft Mode, print speed increases from the maximum of 4 inches per second (ips) at the printer's highest speed setting to a maximum of 5 ips with a 22% reduction in optical density. When a printer is in this user setting, a Draft Mode icon will be displayed. If the printer is in both Power Save mode and Draft Mode, the Power Save icon will display. If the printer is in Draft Mode during a media out condition, the blinking Media Out icon will be displayed.



NOTE: For an explanation and a list of all SGD commands, please refer to the Zebra Programming Guide at: zebra.com/us/en/support-downloads



NOTE: For detailed information on sending SGD commands to the printer using Zebra Setup Utilities, please refer to the Wireless Configuration for 802.11n and Bluetooth Radios for Link-OS Mobile Printers at: zebra.com/us/en/support-downloads



NOTE: Draft Mode printing is optimized for printing receipts comprised of text only with no reverse image, black fill or barcodes present. Draft Mode is designed to operate at temperatures between ambient and the maximum thermal range of the printer.

Verify That the Printer is Working

Before you connect the printer to your computer or portable data terminal, make sure that the printer is in proper working order. You can do this by printing a configuration report using the "two key" method. If you can't get this report to print, refer to [Troubleshooting Tests on page 54](#).

Printing a Configuration Report

1. Turn the printer off. Load the media compartment with journal media (media with no black bars or gaps on the back)
2. Press and hold the Feed Button.
3. Press and release the Power button and keep the Feed button pressed. When printing starts, release the Feed button. The unit will print a line of interlocking "x" characters to ensure all elements of the printhead are working, print out the version of software loaded in the printer and then print the report.

The report indicates model, serial number, baud rate, and more detailed information on the printer's configuration and parameter settings. (See the Troubleshooting Section for sample printouts and a further discussion on how to use the configuration report as a diagnostic tool.)

Connecting the Printer

The printer must establish communications with a host terminal which sends the data to be printed. Communications occur in four basic ways:

- The printers can communicate by cable via either RS-232C or USB 2.0 protocols. Windows drivers that support printing via Serial, USB and the network are included in the Zebra Designer Driver which can be downloaded from zebra.com/drivers.
- By means of a wireless LAN (Local Area Network) per 802.11 specifications. (Optional)
- By means of the Ethernet when docked on the Ethernet cradle.
- By means of a Bluetooth short range radio frequency link.
- WinMobile®, Blackberry®, and Android® devices use standard Bluetooth protocol.
- These printers are compatible with iOS devices, therefore printing via Bluetooth to an Apple® device is possible.



Cable Communication



CAUTION: The printer should be turned off before connecting or disconnecting a communication cable.

The standard cable connection for the printers is USB. The USB port provides 500mA to the A/B port when in host mode and can connect a printer to a PC via a Type A plug to Micro B plug. The cable has a plastic twist lock cap that provides strain relief and locks the cable into the printer housing (see below). Visit zebra.com/accessories for part numbers.

Figure 23 Twist Lock. Rotate in a clockwise direction to lock cable in place.

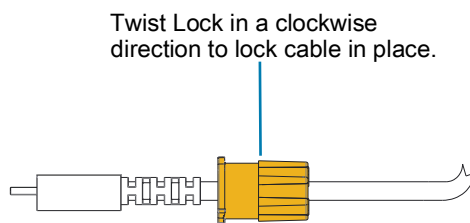
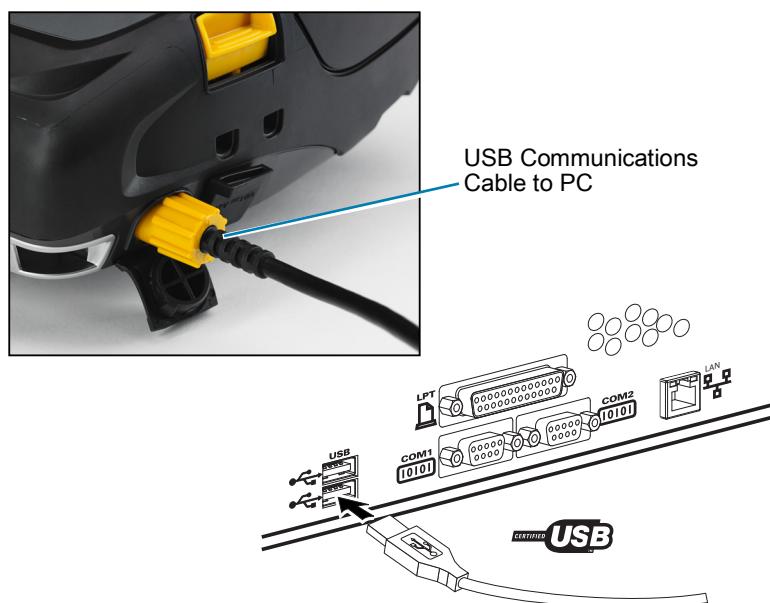

Figure 24 Cable Communication with PC



The small 5-pin connector on the USB cable plugs into the printer, and the connectors are keyed to ensure correct alignment. Do not try to force the cable if it does not plug in as this could damage the pins.

The other end of the cable plugs into the USB port on a computer as shown in [Figure 24](#). The printers are configured with the USB Open HCI interface allowing them to communicate with Windows® based devices.

USB drivers are included in the Zebra Designer Driver which can be downloaded from the Zebra website.

Zebra Setup Utilities

Before you start to configure your printer for use on a Local Area Network (LAN), you will need some basic information which will enable you to establish the network configuration for your printer. Zebra Setup Utilities (ZSU) provides a quick and easy way to configure your printers for a variety of purposes, including setting them up for wireless communications either on a Local Area Network (LAN) or using the international Bluetooth™ communications standard.

Once ZSU has been downloaded to your computer, attach the USB cable to the printer and computer as shown in [Figure 24](#). Refer to Wireless Configuration Guide to follow the steps necessary for setting up and configuring your printer via ZSU.

Go to zebra.com/us/en/support-downloads to download ZSU and the Wireless Configuration Guide.

Zebra Android Printer Setup Utility (for Link-OS Printers)

The printers can also be configured using the Zebra Android Printer Setup Utility. This utility can be downloaded from Google Play to an Android device such as a smartphone or the TC51 or TC56 mobile handheld computers. The Android mobile device can be paired with the printer via Bluetooth or a USB cable and users can quickly navigate the app to perform the following tasks.

Figure 25 Setup Utility Main Screen



Shows currently connected printer

Displays current printer status



= all clear



= error present

Quick access to Wizards, Printer Actions and Files

Wireless Communications with Bluetooth

Bluetooth is a worldwide standard for the exchange of data between two devices via radio frequencies. This form of point-to-point communication does not require access points or other infrastructure. Bluetooth radios are relatively low powered to help prevent interference with other devices running at similar radio frequencies. This limits the range of a Bluetooth device to about 10 meters (32 feet). The default for the printers is Class 2, but the range can be set to Class 1 via a SGD (`bluetooth.power_class`) to increase power. Both the printer and the device it communicates with must follow the Bluetooth standard.

Bluetooth Networking Overview

- Each Bluetooth enabled printer is identified by a unique Bluetooth Device Address (BDADDR). This address resembles a MAC address whereby the first three bytes are vendor, and the last three bytes are device (e.g. 00:22:58:3C:B8:CB).
- This address is labeled on the back of the printer via a barcode for ease of pairing. (For the dual radio, the MAC address label only represents WiFi MAC address.) (Figure 26 on page 39.) In order to exchange data, two Bluetooth enabled devices must establish a connection.
- Bluetooth software is always running in the background, ready to respond to connection requests. One device (known as the client) must request/initiate a connection with another. The second device (the server) then accepts or rejects the connection.
- A Bluetooth enabled printer will normally act as a peripheral creating a miniature network with the terminal sometimes referred to as a "piconet". Discovery identifies Bluetooth devices that are available for pairing whereby the central device broadcasts a discovery request and devices respond. If a device is not discoverable, the central cannot pair unless it knows the BDADDR or has previously paired with the device.
- If both devices support Bluetooth 2.1 or higher they will use Security Level 4 Secure Simple Pairing (SSP), a mandatory security architecture that features two association models: Numeric Comparison and Just Works (no user confirmation).

Bluetooth (BT) Security Modes

Security Mode 1	Security Mode 2	Security Mode 3
If a BT device greater than or equal to 2.1 is pairing with a BT device less than or equal to 2.1, it falls back to BT 2.0 compatibility mode and behaves the same as BT 2.0. If both BT devices are greater than or equal to 2.1, Secure Simple Pairing must be used according to the BT spec.	If a BT device greater than or equal to 2.1 is pairing with a BT device less than or equal to 2.0, it falls back to BT 2.0 compatibility mode and behaves the same as BT 2.0. If both BT devices are greater than or equal to 2.1, Secure Simple Pairing must be used according to the BT spec.	Same as Security Mode 2.

Security Mode 4: Simple Secure Pairing
<p>Simple Secure Pairing:</p> <ul style="list-style-type: none"> • A new security architecture introduced supported in BT \geq 2.1. • Service-level enforced, similar to mode 2. • Mandatory when both devices are BT \geq 2.1. • There are four association models currently supported by mode 4. • Security requirements for services must be classified as one of the following: authenticated link key required, unauthenticated link key required, or no security required. SSP improves security through the addition of ECDH public key cryptography for protection against passive eavesdropping and man-in-the-middle (MITM) attacks during pairing.

Numeric Comparison	Just Works
<ul style="list-style-type: none"> • Designed for situation where both devices are capable of displaying a six-digit number and allowing user to enter “yes” or “no” response. • During pairing, user enters “yes” if number displayed on both devices matches to complete pairing. Differs from the use of PINs in legacy (BT\leq2.0) pairing because the number displayed for comparison is not used for subsequent link key generation, so even if it is viewed or captured by an attacker, it could not be used to determine the resulting link or encryption key. 	<ul style="list-style-type: none"> • Designed for situation where one (or both) of the pairing devices has neither a display nor keyboard for entering digits (e.g. Bluetooth headset). It performs authentication step 1 in the same manner as a numeric comparison, but the user cannot verify that both values match, so MITM (man-in-the-middle) protection is not provided. This is the only model in SSP that does not provide authenticated link keys.

Each mode, except for Just Works, has Man-In-The-Middle (MITM) protection, meaning no third device can view the data being passed between the two devices involved. The SSP mode is usually negotiated automatically based on the capabilities of both the central and peripheral. Lower security modes can be disabled via the `bluetooth.minimum_security_mode` SGD. The `bluetooth.minimum_security_mode` SGD sets the lowest security level at which the printer will establish a Bluetooth connection. The printer will always connect at a higher security level if requested by the central device. To change the security mode and security settings in the printers, use Zebra Setup Utilities.

Bluetooth Minimum Security Modes

	BT Version of central Device (>2.1)
bluetooth.minimum_security_mode=1	Secure Simple Pairing Just Works/Numeric Comparison
bluetooth.minimum_security_mode=2	Secure Simple Pairing Just Works/Numeric Comparison
bluetooth.minimum_security_mode=3	Secure Simple Pairing Numeric Comparison
bluetooth.minimum_security_mode=4	Secure Simple Pairing Numeric Comparison
bluetooth.bluetooth_PIN	Not Used



IMPORTANT: `bluetooth.minimum_security_mode` sets the lowest security level at which the printer will establish a Bluetooth connection. The printer will always connect at a higher security level if requested by the central device.

The printers also feature bonding for Bluetooth. The printer caches pairing info so devices stay paired through power cycles and disconnects. This eliminates the need to repair on every connection establishment.

The `bluetooth.bonding` SGD is on by default.



NOTE: For detailed information on Bluetooth, please refer to the ZQ500 Series product page at: zebra.com/us/en/support-downloads

All Link-OS firmware versions prior to version 6.0

In all versions of Link-OS firmware prior to version 6.0, if `bluetooth.discoverable` is set to “on”, the printer enters General Discoverable mode. It responds to discovery requests at any time, and is connectable and pairable. If set to “off”, the printer is not discoverable, but it is still connectable and pairable. The default was “on”.

Link-OS firmware version 6.0

If `bluetooth.discoverable` is set to “on”, the behavior is the same as pre-6.0 firmware. The printer enters General Discoverable mode and is connectable and pairable. If set to “off”, the printer is not discoverable, is still connectable and pairable. The default was changed to “off”. A new feature was added to all printers called “Limited Pairing Mode” that turns on a limited discoverability and pairing window to users who have physical access to the printer. If the user holds the feed key for 5 seconds, the printer enters limited pairing mode for 2 minutes.

Link-OS firmware versions 6.1 and later

If `bluetooth.minimum_security_mode` is set to “1”, unconditionally enable pairing, regardless of the `bluetooth.discoverable` mode setting. If `bluetooth.minimum_security_mode` is set to a value other than 1, pairing is not allowed if discoverable is set to “off” and the printer is not in limited pairing mode.



NOTE: Discoverability does not apply to Bluetooth LE. For Zebra printers that support Bluetooth LE, the `bluetooth.discoverable` setting affects pairing exact

WLAN Overview

The printers are optionally equipped with a Dual Radio that uses the industry standard 802.11ac protocols and Bluetooth 4.1. They will have the FCC ID number on the serial number label on the back of the unit.

- Wireless Network Printers with the Zebra 802.11ac WLAN radio module can be identified by the text “Wireless Network Printer” on the serial number label on the back of the printer.
- These printers allow communication as a node within a wireless local area network (WLAN). Methods of establishing communications to the printer will vary with each application.

More information and LAN configuration utilities are included in the ZebraNet Bridge Enterprise™ program (version 2.8 and later).

Zebra Setup Utilities (ZSU) and Zebra Mobile Setup Utility can also be used to configure WLAN communications settings. Both ZebraNet Bridge Enterprise and ZSU may be downloaded from the Zebra Web site.

Figure 26 BT/WLAN Communications



Setting Up the Software

The printers use Zebra’s CPCL and ZPL Programming languages which were designed for mobile printing applications. CPCL and ZPL are fully described in the Zebra Programming Guide, CPCL Programming Guide, and ZPL II Programming Guide available on-line at zebra.com/us/en/support-downloads. You can also use ZebraDesigner Pro v2, Zebra’s Windows® based label creation program which uses a graphical interface to create and edit labels in either language.

Designing Labels

The following examples provide guidelines for designing labels for the printers, specifically for Gap Media, Black Bar Media and Journal Media. The illustrations for each media type define recommended tolerances, keep-out zones and safe printing zones designed to avoid any vertical registration issues during printing. Dimensions are determined based on product registration capabilities and Zebra-recommended media tolerances.

Figure 27 Gap Media

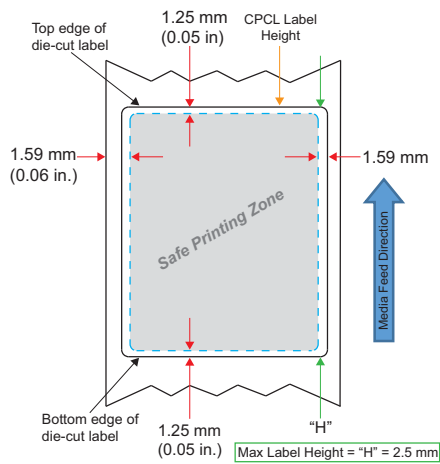

Figure 28 Journal Media

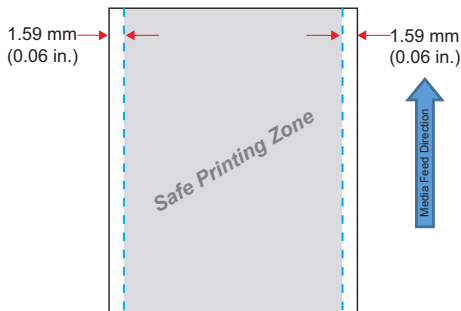
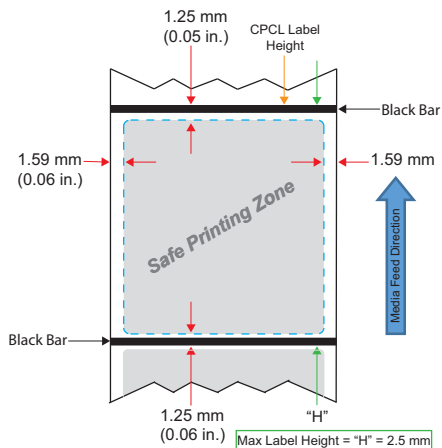

Figure 29 Black Bar Label Media



Using Pre-Printed Receipt Media

For alignment of pre-printed documents to Top of Form (TOF), the use of a black mark is necessary. The black bar can be placed on the back of the documents by following the recommendation below.

The black bar can also be placed on the front of the document. The user must change the `media.bar_location` setting to "front".

Black Mark Dimensions (Receipt Media)

The reflective media black marks (or black bar/marks) should extend past the centerline of the roll on the front side of the paper.

- Minimum mark width: 15 mm (0.59 in.) perpendicular to the edge of the media, and centered within the width of the roll.
- Mark length: 4.8 - 6.0 mm (0.19 - 0.24 in.) parallel to the edge of the media.

Label Areas

The media/black bar sensor detects the dark, pre-printed bar on the media, so a path in the center of the paper must be kept free of dark, pre-printed graphics.



NOTE: Dark, pre-printed graphics refer to any symbols, barcodes, text and/or colored areas that have been applied to the receipt paper rolls before they have ever been used in the printer.

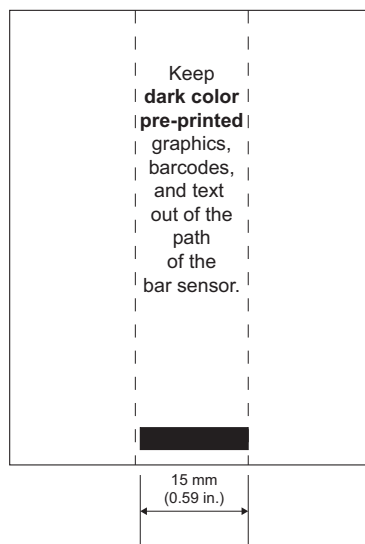
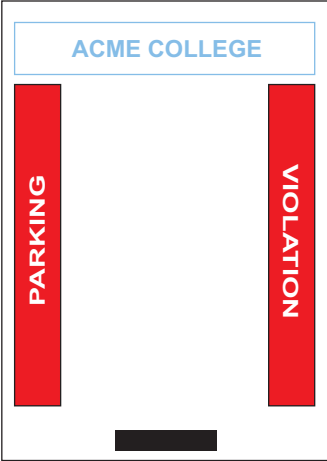

Figure 30 Label Areas



Label Design Examples

This section shows examples of labels with and without problems with the black mark located in the front of the document.

Figure 31 Label Design Examples

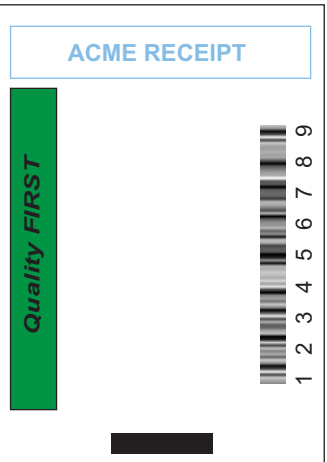
Problem Label Designs	Good Label Designs
	
<p>The dark colors, pre-printed text, and graphics are in the path of the black bar at the bottom of the receipt.</p>	<p>The center path to the black bar is free of dark colors, pre-printed text, and graphics.</p>
	



NOTE: Complete information on using pre-printed receipt paper can be found in the FORM command in the CPCL Programming Guide at zebra.com/manuals.

Keep-Out Areas

At times, incomplete printing of text and/or graphics appear because minimum margins are not provided during label design. The recommended minimum margins, or “keep out areas” are shown in [Figure 32](#).

Figure 32 Keep Out Areas

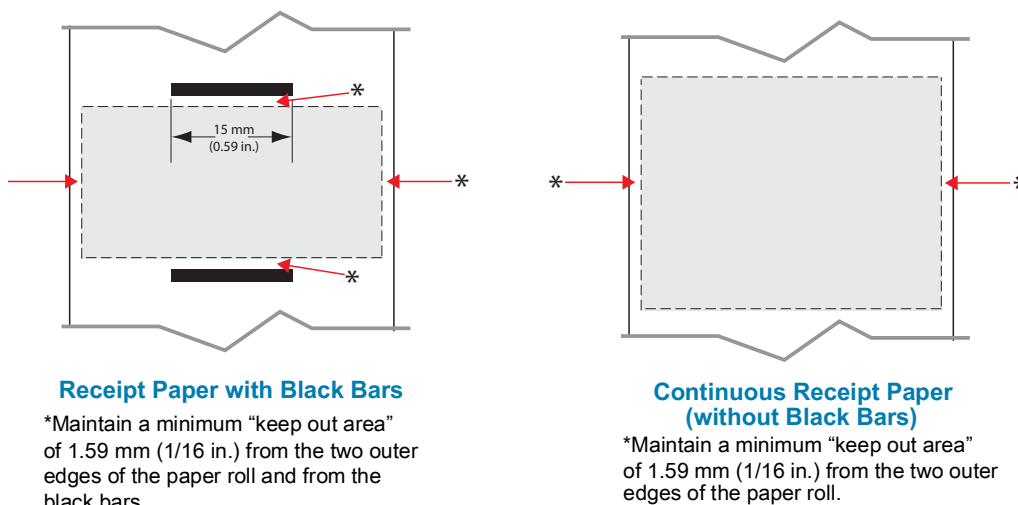

NOTE: The length of each “continuous” receipt is determined by the data sent to the printer.

Near Field Communication (NFC)

Much like Bluetooth and Wi-Fi technologies, Near Field Communication (NFC) allows wireless communication and data exchange between digital devices like smartphones. Yet NFC utilizes electromagnetic radio fields while technologies such as Bluetooth and Wi-Fi focus on radio transmissions instead.

NFC is a sub-class of Radio Frequency Identification (RFID) technology that is designed for use by devices within close proximity to each other. NFC technology allows devices to establish communication by touching or bringing them into close proximity, usually no more than 7.62 centimeters (3 inches).

The printer contains a passive NFC device which contains information that other devices can read but does not read any information itself

An active device, such as a smartphone, can read the information on the printer’s NFC tag, but the tag itself does nothing except transmit the info to authorized devices.

Active devices can read information and send data. An active NFC device, like a smartphone, would not only be able to collect information from NFC tags, but it would also be able to exchange information with other compatible phones or devices. An active device could even alter the information on the NFC tag if authorized to make such changes. To ensure security, NFC often establishes a secure channel and uses encryption when sending sensitive information.

Figure 33 NFC Pairing Using Print Touch™



<http://www.zebra.com/nfc>

NFC Use Cases

Passive

- Bluetooth Pairing – used to cause a tablet, smart phone or terminal to automatically pair with the printer via a Bluetooth connection, within the bounds of the security profile being used. This shall contain the BT address and serial number of the printer.
- App launching – used to cause an app, developed either by Zebra or a third party to be executed on a smart phone, tablet or terminal.
- Web site launching – used to cause a smart phone, tablet or terminal to display a web site developed by Zebra or a third party developer.



Tapping the Zebra Print Touch™ icon with a Near Field Communication (NFC) enabled smartphone will provide instant access to printer-specific information. For more information about NFC and Zebra products, go to zebra.com/nfc. Bluetooth pairing applications via NFC is also possible. Please see Zebra Multi-platform SDK for more information.

Wearing the Printer

Swivel Belt Clip

The printers have a plastic swivel belt clip included as a standard feature. (It should be noted that printers with extended capacity battery do not come equipped with a belt clip.) To use: hook the clip over your belt, and ensure that the clip is securely attached to the belt. The belt clip will pivot to allow you to move freely while wearing the printer. In order to install or remove the plastic Belt Clip, secure it to the cut-out in the front of the printer (where shown).

Figure 34 Printer with Belt Clip



Hand Strap

The Hand Strap accessory attaches to the front posts of the printer to provide the user with a convenient and secure method of carrying the printer. To attach the Hand Strap to the printer:

1. Attach one swivel snap hook to its corresponding post on the front of the printer.
2. Attach the opposite end of the strap to its corresponding post on the front of the printer where shown.

Figure 35 Hand Strap

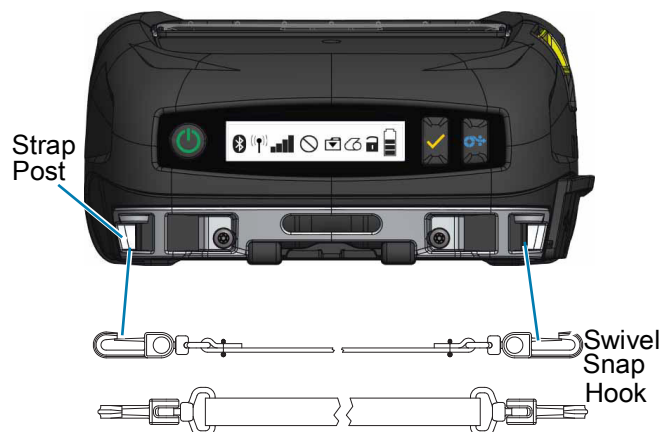

Shoulder Strap

A Shoulder Strap accessory is also offered to provide another option for comfortably carrying the ZQ511 and ZQ521 printers. Similar to the Hand Strap, the shoulder strap attaches to the two strap posts on the front of the printer via rugged swivel snap hooks as shown in [Figure 36](#). The strap is easily adjustable up to 56 inches from end to end.

Figure 36 Shoulder Strap

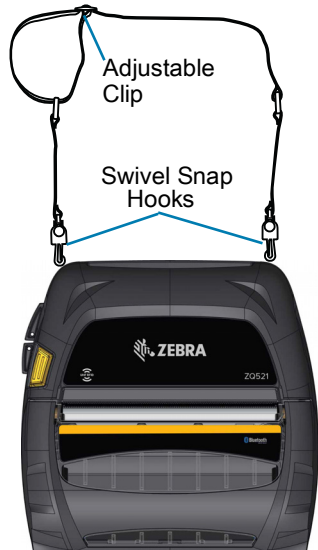

Soft Case

The printers have an environmental Soft Case option that helps protect the printer, while also allowing the user to carry it from their belt. The paper path is left open to maintain printing capability and the controls are visible and accessible while in the case. D-Ring connectors allow for attachment to the shoulder strap option.

Figure 37 Soft Case



Exoskeleton

In order to provide extreme ruggedness for the printers, they come with an optional hard case, or “Exoskeleton”. This case features a clam shell design whereby the printer is placed securely inside and the Exoskeleton is clamped shut. The Exoskeleton comes with a shoulder strap for easy portability.

All printer ports are inaccessible while the printer is in the hard case, but the printer control buttons can still be used (Figure 38). The user will also be able to mount and charge the printer on the Vehicle Cradle and 4-Bay Power Station while in the hard case.



NOTE: Since linerless printers don't have the reverse tear bar feature which allows media to be torn both upwards and downwards, it is recommended that linerless printers not be used with the Exoskeleton. Linerless media can only be torn down and the Exoskeleton is not resistant to the adhesive of the linerless media.

Figure 38 Exoskeleton

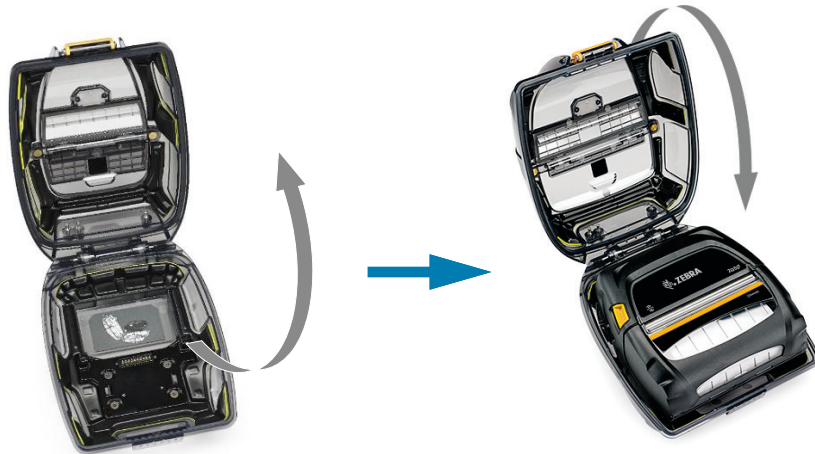

NOTE: For more information on accessories for the ZQ500 printers, see [Accessories on page 64](#).

Preventive Maintenance

Extending Battery Life

- Never expose the battery to direct sunlight or temperatures over 40°C (104°F) when charging.
- Always use a Zebra charger designed specifically for Lithium-Ion batteries. Use of any other kind of charger may damage the battery.
- Use the correct media for your printing requirements. An authorized Zebra re-seller can help you determine the optimum media for your application.
- If you print the same text or graphic on every label, consider using a pre-printed label.
- Choose the correct print darkness, and print speed for your media.
- Use software handshaking (XON/XOFF) whenever possible.
- Remove the battery if the printer won't be used for a day or more and you're not performing a maintenance charge.
- Consider purchasing an extra battery.
- Remember that any rechargeable battery will lose its ability to maintain a charge over time. It can only be recharged a finite number of times before it must be replaced. Always dispose of batteries properly. See [Product Disposal on page 69](#) for more information on battery disposal.

General Cleaning Instructions



CAUTION: Avoid possible personal injury or damage to the printer. Never insert any pointed or sharp objects into the printer. Always turn off the printer before performing any cleaning procedures. Use care when working near the tear bars as the edges are very sharp.



CAUTION—HOT SURFACE: The printhead can get very hot after prolonged printing. Allow it to cool off before attempting any cleaning procedures.



IMPORTANT: Only use a Zebra cleaning pen (not supplied with the printer) or a cotton swab with 90% medical grade alcohol for cleaning the printhead.



CAUTION: Use only cleaning agents specified in the following tables. Zebra Technologies Corporation will not be responsible for damage caused by any other cleaning materials used on this printer.

Area	Method	Interval
Printhead	Use a Zebra cleaning pen to swab the thin gray line on the printhead, cleaning the print elements from the center to the outside edges of the printhead.	After every five rolls of media (or more often, if needed). When using linerless type media, cleaning is required after every roll of media.
Platen Surface (Linered)	Rotate the platen roller and clean it thoroughly with a fiber-free swab, or lint free, clean, damp cloth lightly moistened with medical grade alcohol (90% pure or better). (Figure 39)	After every five rolls of media (or more often, if needed)
Platen Surface (Linerless)	Rotate platen roller and clean with a fiber-free swab and 1 part liquid soap (Palmolive or Dawn) and 25 parts water. Use pure water to clean after soap/water mixture. (Figure 40)	Clean platen only if there is an issue during printing, such as media not releasing from the platen. (*See Note below.)
Scraper (Linerless Units Only)	Use adhesive side of media to clean scraper on linerless units. (Figure 40)	After every five rolls of media (or more often, if needed).
Tear Bar	Clean thoroughly with 90% medical grade alcohol and a cotton swab. (Figure 39)	As needed
Printer Exterior	Water-dampened cloth or 90% medical grade alcohol wipe.	As needed
Printer Interior	Gently brush out printer. Ensure the Bar Sensor and Gap Sensor windows are free of dust. (Figure 39)	As needed
Interior of units with Linerless Platens	Clean thoroughly with 90% medical grade alcohol and a fiber-free swab. (See Figure 40 for specific target areas for interior cleaning.)	After every five rolls of media (or more often, if needed).



NOTE: This is an emergency procedure only to remove foreign contaminants (oils, dirt) from the platen that can damage the printhead or other printer components. This procedure will shorten or even exhaust the linerless platen's useable life. If the linerless media continues to bind after cleaning and feeding 1 to 2 meters (3 to 5 feet) of media, replace the platen.

Figure 39 Cleaning Locations (Linered Printer)

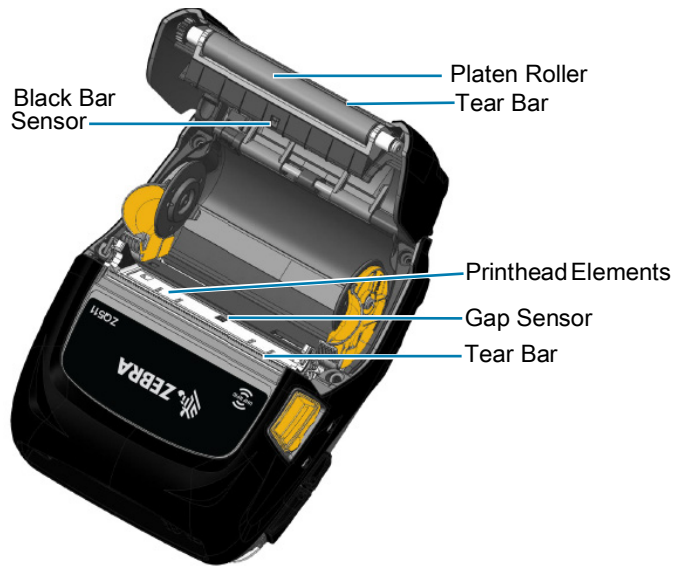
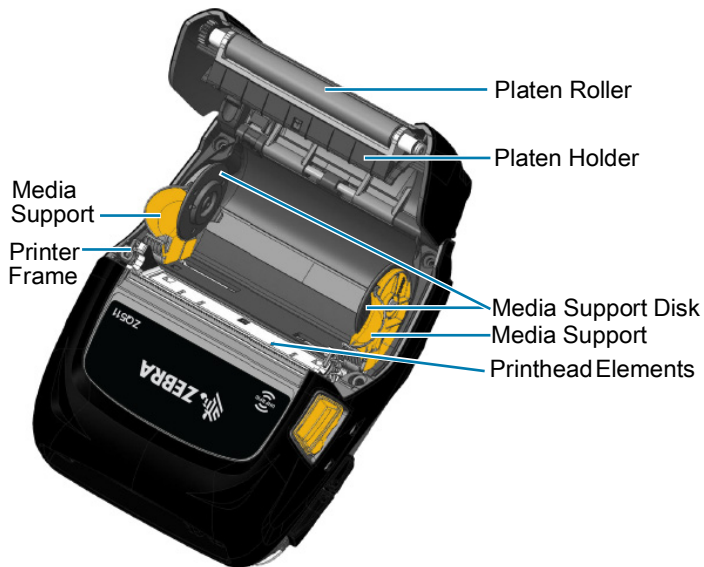





Figure 40 Cleaning Locations (Linerless Printer)



Troubleshooting



Front Control Panel









If the printer is not functioning properly, refer to the table below to determine the state of the LED indicator ring located around the Power button.

LED Indicator	LED State	Indication
	Solid Green	Charged Battery; Battery Eliminator in Use
	Blinking Green	Sleep Mode
	Solid Amber	Battery Charging
	Solid Red	Battery Fault

Printer Status Indicators

The printer's control panel displays multiple icons which indicate the status of various printer functions. Check the indicator status and then refer to the Troubleshooting topic referenced on the following pages to resolve the problem.

Icon	Status	Indication
	On	Bluetooth link established
	Grayed Out	Inactive
	Blinking	Receiving printer data
	Not Present	No WLAN radio detected
	Antenna Blinking	Looking for AP
	Antenna Blinking/1 Parenthesis Solid	WLAN Associated/Attempting Authentication
	Antenna and 2 Parentheses Solid	WLAN Associated and Authenticated
	Antenna and 2 Parentheses Blinking	Receiving Data

Icon	Status	Indication
	4 Bars	802.11 Signal Strength >75%
	3 Bars	802.11 Signal Strength <=75%
	2 Bars	802.11 Signal Strength <= 50% but >25%
	1 Bar	802.11 Signal Strength <= 25%
	0 Bars	No network detected
	On	Bluetooth link established
	Grayed Out	Inactive
	Blinking	Data processing in progress
	Steady	No data being received
	Blinking	Out of media
	Steady	Media present
	Blinking	Media cover open
	4 Bars	>80% charged
	3 Bars	60%-80% charged
	2 Bars	40%-60% charged
	1 Bar	20%-40% charged
	0 Bars	Low Battery
	On	Battery Eliminator present (Replaces Battery icons)
	On (Media Out icon Off)	Printer in Segmentation Mode
	On (Media Out icon Off)	Printer in Draft Mode

Troubleshooting Topics

No power

- Check that the battery is installed properly.
- Recharge or replace the battery as necessary.
- If using the battery eliminator to power the printer, ensure that it is connected properly to an active (ON) source.



CAUTION: Always dispose of batteries properly. Refer to [Battery Disposal on page 69](#) for more information on proper battery disposal.

Media does not feed

- Be sure the media cover is closed and latched.
- Check the spindle holding media for any binding.
- Ensure that the label sensor is not blocked.

Poor or faded print

- Clean the printhead.
- Check the quality of media.

Partial or missing print

- Check the media alignment.
- Clean the print head.
- Ensure that the media cover is properly closed and latched.

Garbled print

- Replace the battery.
- Check the cable to the terminal.
- Establish RF Link and/or restore LAN association.

No print

- Replace the battery.
- Check the cable to the terminal.
- Establish an RF Link and/or restore LAN association.
- Check for an invalid label format or command structure. Place the printer in Communications Diagnostic (Hex Dump) Mode to diagnose the problem.

Reduced battery charge life

- If the battery is more than 1 year old, short charge life may be due to normal aging.
- Check the battery health.
- Replace the battery.

Data icon flashing

- No action is needed. A flashing Data icon is normal while data is being received.

Media or Cover Open icons flashing

- Check to see if media is loaded and that the media cover is closed and securely latched.

Communication error

- Check the cable to computer or laptop, and if necessary, replace the cable.

Label binding

- Open the head release latch and media cover.
- Remove and reinstall the media.

Blank LCD screen

- Make sure the printer is turned on.
- Check to see if application is loaded or corrupted: If so, reload the program.
- Check the LED ring around the Power button to see if it is blinking green indicating the printer is in sleep mode. Press Power or Select buttons to “wake up” the printer.

No NFC Connectivity

- Ensure that your smartphone is positioned 3 inches (7.62 cm) or closer to the Print Touch icon on the side of the printer.

Troubleshooting Tests

Printing a Configuration Report

To print out a listing of the printer’s current configuration follow these steps:

1. Turn the printer off. Load the media compartment with journal media (media with no black bars printed on the back).
2. Press and hold the Feed button.
3. While pressing the Feed button, press and release the Power button.
4. When printing starts, release the Feed button.

Refer to [Figure 41 on page 55](#) for sample configuration reports.

Figure 41 ZQ521 configuration report Example

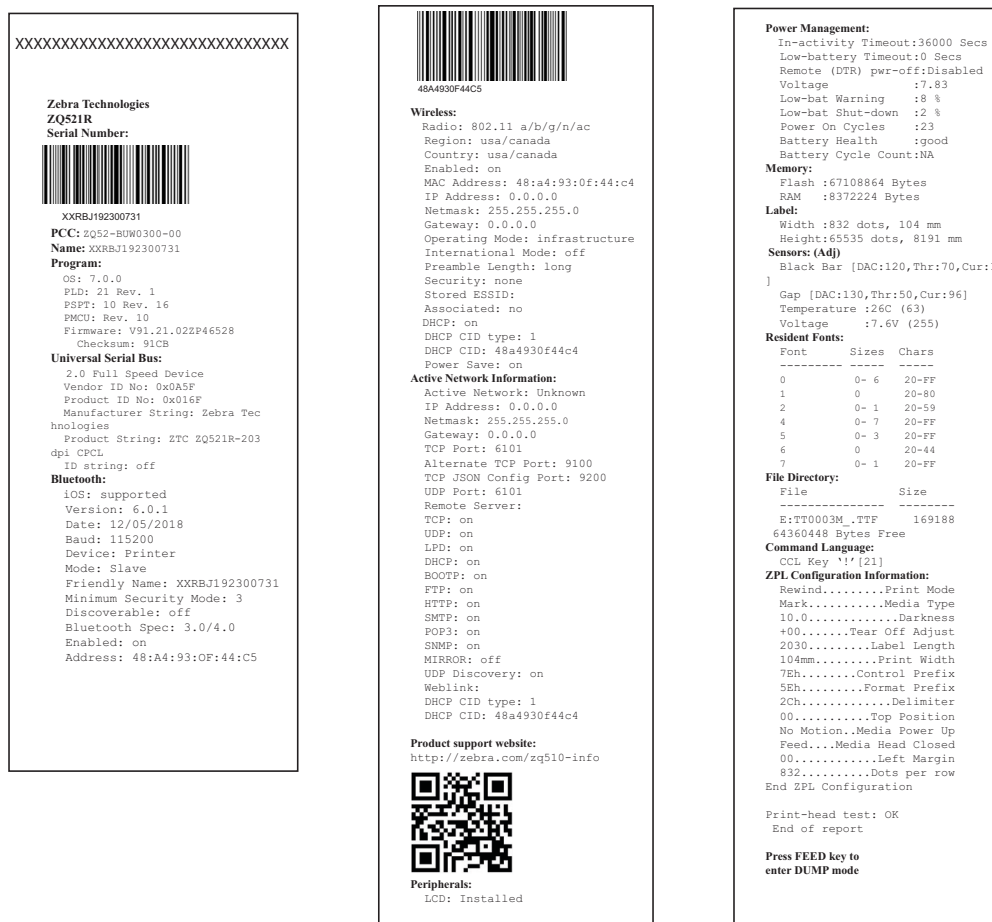

Communications Diagnostics

If there is a problem transferring data between the computer and the printer, try putting the printer in the Communications Diagnostics Mode (also referred to as the “DUMP” mode). The printer will print the ASCII characters and their text representation (or the period ‘.’, if not a printable character) for any data received from the host computer.

To enter Communications Diagnostics Mode:

1. Print a configuration report as described above.
2. At the end of the diagnostics report, the printer will print: “Press FEED key to enter DUMP mode”.
3. Press the FEED key. The printer will print: “Entering DUMP mode”.



NOTE: If the FEED key is not pressed within 3 seconds, the printer will print “DUMP mode not entered” and will resume normal operation.

At this point, the printer is in DUMP mode and will print the ASCII hex codes of any data sent to it, and their text representation (or “.” if not a printable character).

Additionally, a file with a “.dmp” extension containing the ASCII information will be created and stored in the printer’s memory. It can be viewed, “cloned” or deleted using the Net Bridge application. (Refer to the ZebraNet Bridge Enterprise documentation for more information.)

To terminate the Communications Diagnostics Mode and return the printer to normal operations:

1. Turn the printer OFF.
2. Wait 5 seconds.
3. Turn the printer ON.

Contacting Technical Support

If the printer fails to print the configuration report, or you encounter problems not covered in the Troubleshooting Guide, contact Zebra Technical Support. To contact product support in your region, go to: zebra.com/contact

You will need to supply the following information:

- Model number (e.g. ZQ511 and ZQ521)
- Unit serial number (Found on the large label on the back of the printer, also found in the configuration report printout.)
- Product Configuration Code (PCC) (15 digit number found on the label on the back of the unit)

Specifications



NOTE: Printer specifications are subject to change without notice.

Printing Specifications

Parameter	ZQ521	ZQ511
Print Width	Up to 104 mm (4.09 in.)	Up to 72 mm (2.83 in.)
Print Speed	Up to 127 mm (5 in.)/second @ 12% max density 76.2 mm (3 in.)/second @ 16% max density (linerless)	Same
Printhead Burn Line to Tear Edge Distance	Front Side: 4.8 mm (0.18 in.) +/- 0.5 mm (0.02 in.) Reverse Side (Linered): 6.2 mm (0.24 in.) +/- 0.5 mm (0.02 in.)	Same
Printhead Life	600K inches of paper feed MTBF of output at 18% density at 20°C when using virgin media.	Same
Print Density	203 dots/in. or better	Same

Memory and Communications Specifications

Parameter	ZQ511 and ZQ521 Printers
Flash Memory	512 MB ^a
RAM Memory	256 MB ^a
Standard Communications	USB (Micro AB on the go)
Wireless Communication Options	1. Standalone Bluetooth Classic and BLE Radio 2. 802.11AC/BT/BLE Combo Radio

a. Memory configuration on your printer may be found by referring to the [Printing a Configuration Report on page 54](#).

Label Specifications

Parameter	ZQ521	ZQ511
Media Width	51 mm (2.0 in.) to 113 mm (4.45 in.) +1 mm	35 mm (1.37 in.) to 80 mm (3.15 in.) +1 mm
Media Length	12.5 mm (0.5) minimum	Same
Black Bar Sensor to Printhead Burnline Distance	15.87 mm (0.62 in.) +/- 0.635 mm (0.025 in.)	Same
Media Thickness (except Tag)	2.1 to 6.5 mils (0.053 to 0.1651 mm)	Linerless: 2.1 to 6.5 mils (0.053 to 0.1651 mm) Lined: 2.3 to 6.5 mils (0.05842 to 0.1651 mm)
Max Tag Thickness	2.3 to 5.5 mils (0.05842 to 0.1397 mm)	Same
Max Label Roll Outer Diameter	57 mm (2.24 in.)	51 mm (2.0 in.)
Inner Core Diameters**	19 mm (0.75 in.) standard 12.5 mm (0.5 in.) optional*	Same
Black Mark Location	The reflective media black marks should be centered on media roll	Same
Black Mark Dimensions	Minimum mark width: 12,7 mm (0.5 in.) perpendicular to inside edge of media, centered within the width of the roll. Mark length: 2.4-11 mm (0.09 to 0.43 in.) parallel to inside edge of media.)	Same



NOTE: Customers who want to use the 12.5 mm (0.5 in.) core size will be required to uninstall the media disks and install new media support disks.

CPCL Font and Bar Code Specifications and Commands

Item	Available Options
Standard Fonts	25 bit-mapped fonts; 1 scalable font (CG Trimvirate Bold Condensed*) *Contains UFST from Agfa Monotype Corporation Downloadable optional bit-mapped and scalable fonts via Net Bridge software.
International Character Sets	Chinese 16 x 16 (traditional) Chinese 16 x 16 (simplified) Chinese 24 x 24 (simplified) Japanese 16 x 16 Japanese 24 x 24
Linear Bar Codes	Aztec (AZTEC) Codabar (CODABAR, CODABAR 16) UCC/EAN 128 (UCCEAN128) Code 39 (39, 39C, F39, F39C) Code 93 (93) Code 128 (128) EAN 8, 13, 2 and 5 digit extensions (EAN8, EAN82, EAN85, EAN13, EAN132, and EAN135) EAN-8 Composite (EAN8) EAN-13 Composite (EAN13) Plessey (PLESSEY) Interleaved 2 of 5 (I2OF5) MSI (MSI, MSI10, MSI1110) FIM/POSTNET (FIM) TLC39 (TLC39) UCC Composite A/B/C (128(Auto)) UPCA, 2 and 5 digit extensions (UPCA2 and UPCA5) UPCA Composite (UPCA) UPCE, 2 and 5 digit extensions (UPCE2 and UPCE5) UPCE Composite (UPCE) MaxiCode (MAXICODE) PDF 417 (PDF-417) Datamatrix (using ZPL emulation) (DATAMATRIX) QR Code (QR)
2-D Bar Codes	RSS-14 (RSS-Subtype 1) RSS-14 Truncated (RSS-Subtype 2) RSS-14 Stacked (RSS-Subtype 3) RSS-14 Stacked Omnidirectional (RSS-Subtype 4) RSS Limited (RSS-Subtype 5) RSS Expanded (RSS-Subtype 6)
Rotation Angles	0°, 90°, 180°, and 270°

ZPL Font and Bar Code Specifications and Commands

Item	Available Options
Standard Fonts	15 bit-mapped fonts; 1 scalable font (CG Trimvirate Bold Condensed) Downloadable optional bit-mapped and scalable fonts via Net Bridge software.
International Font Options	Zebra offers font kits covering multiple languages including Simplified and Traditional Chinese, Japanese, Korean, Hebrew/Arabic, and others.
Linear Bar Codes 2-D Bar Codes	Barcode (CPCL Command) Aztec (^B0) Codabar (^BK) Codablock (^BB) Code 11 (^B1) Code 39 (^B3) Code 49 (B4) Code 93 (^BA) Code 128 (^BC) DataMatrix (^BX) EAN-8 (^B8) EAN-13 (^BE) GS1 DataBar Omnidirectional (^BR) Industrial 2 of 5 (^BI) Interleaved 2 of 5 (^B2) ISBT-128 (^BC) LOGMARS (^BL) Micro-PDF417 (^BF) MSI (^BM) PDF-417 (^B7) Planet Code (^B5) Plessey (^BP) Postnet (^BZ) Standard 2 of 5 (^BJ) TLC39 (^BT) UPC/EAN extensions (^BS) UPC-A (^BU) UPC-E (^B9) Maxi Code (^BD) QR Code (^BQ)
Rotation Angles	0°, 90°, 180°, and 270°

Communication Port

USB

Figure 40 USB Port

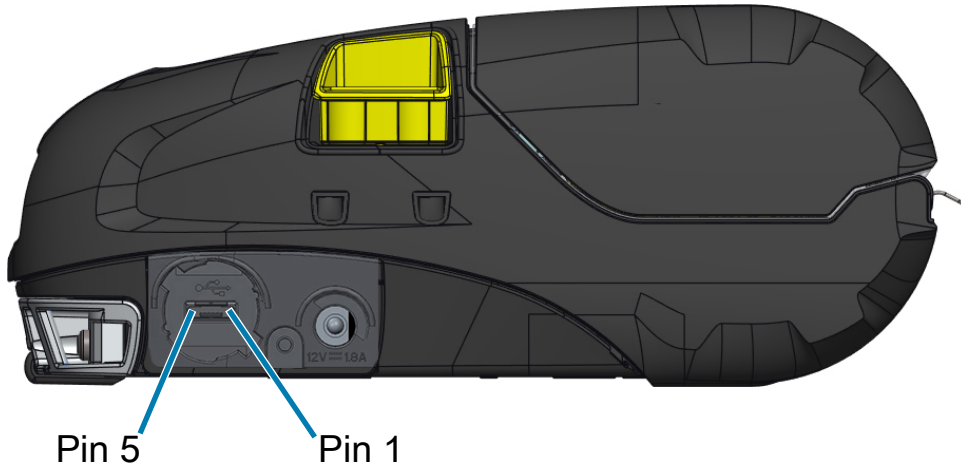

Pin #	Signal Name
1	VBUS
2	DM(-)
3	DP(+)
4	ID
5	GND

Physical, Environmental and Electrical Specifications

Parameter	ZQ521	ZQ511
Weight w/ battery	1.6 lbs. (0.75 kg)	1.35 lbs. (0.61 kg)
Temperature	Operating: -20°C to 55°C (-4°F to 131°F)	Same
	Storage: -30°C to 66°C (-22°F to 150.8°F)	Same
	Charging: 0°C to 40°C (32°F to 104°F)	Same
Relative Humidity	Operating/Storage: 10% to 90% non-condensing	Same
Battery	Smart Battery (2 or 4 cell) Lithium-Ion, 7.4 VDC (nominal); 2.45 Ahr min.	Same
Intrusion Protection (IP) Rating	IP54 (without soft case)	Same
	IP65 (with hard case)	

Figure 41 ZQ511 Dimensions



Height - 61 mm (2.40 in.)
Width - 120 mm (4.7 in.)
Length - 150 mm (5.9 in.)

Figure 42 ZQ521 Dimensions

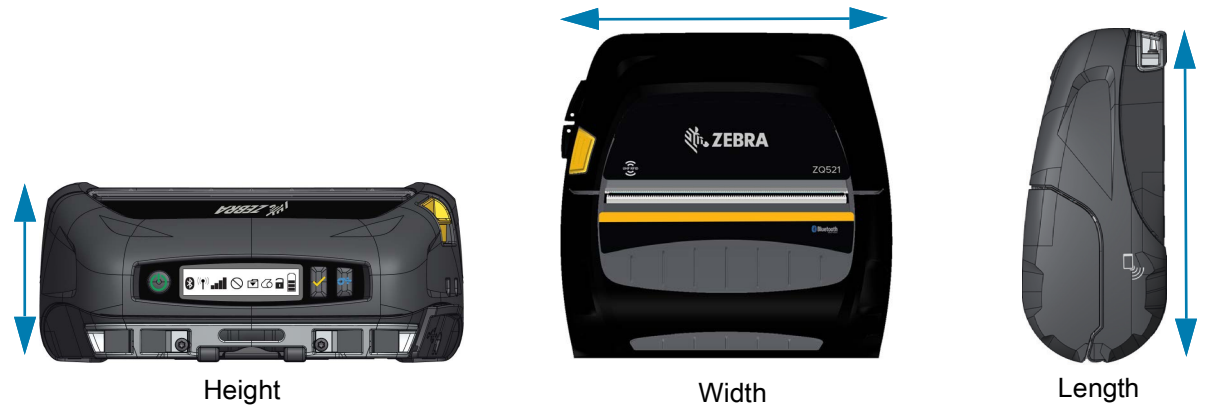

Height - 67 mm (2.6 in.)
Width - 155 mm (6.1 in.)
Length - 150 mm (5.9 in.)

Specifications

Figure 43 Mounting Hole Dimensions

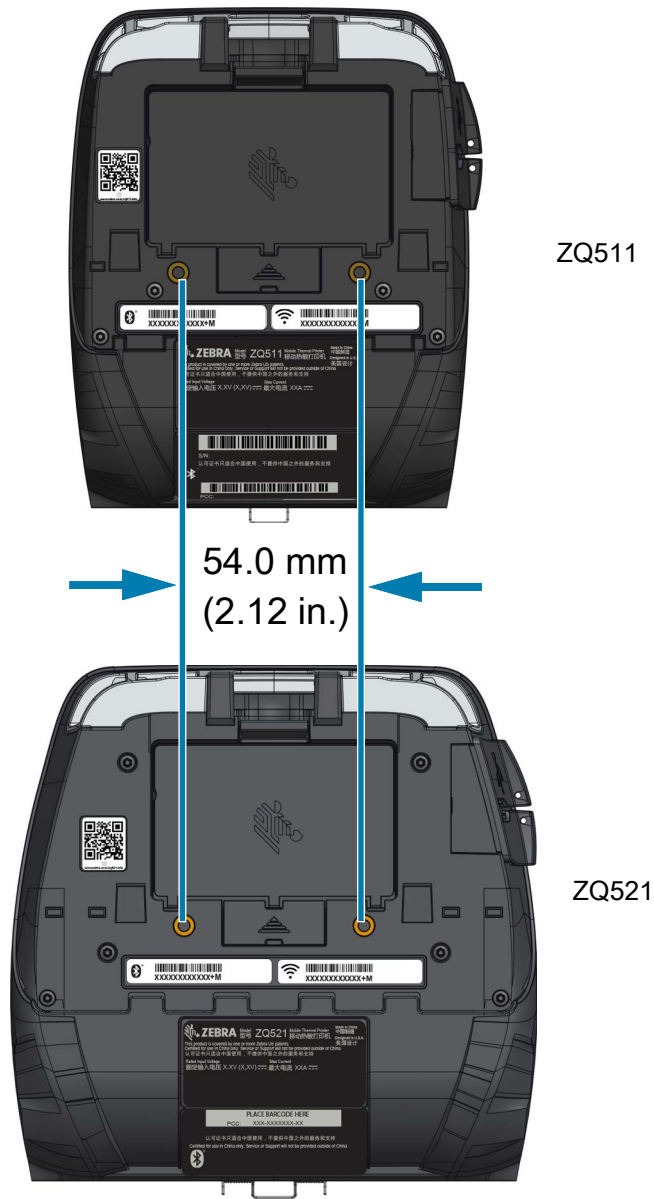

NOTE: Use two M4 x 8.0 mm screws in the indicated positions

Accessories

For a complete list of printer accessories, go to zebra.com/manuals, search for the Mobile Printer Accessories Guide, and go to the ZQ500 Series product page for a complete list of accessories. Or scan the following QR code with a mobile device to access the guide.

Figure 44 Accessories Guide QR Code



Miscellaneous

Serial Number and PCC Number Locations

Figure 45 ZQ511 (Bottom View)

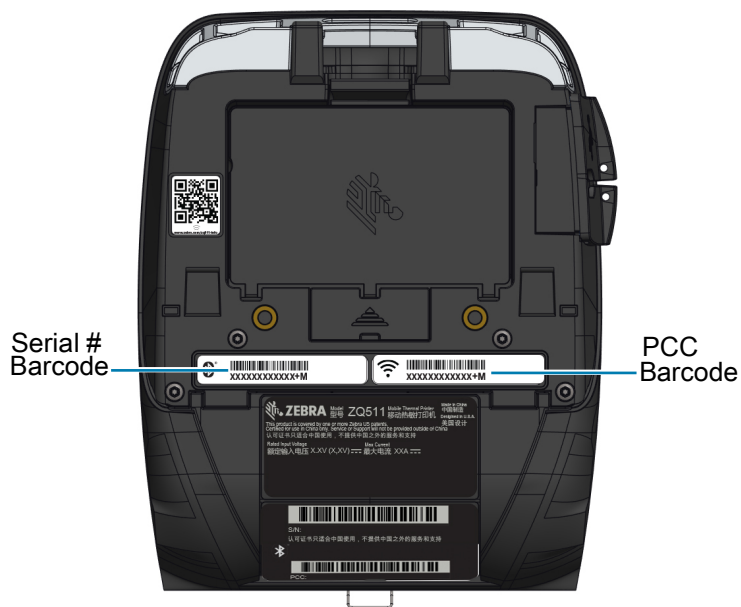

IMPORTANT: Due to compliance and customs restraints, an integrator may not be able to ship a printer purchased in one country to another country based on the limitations imposed by regional SKUs. The country code identified in the printer SKU determines the area of the world in which the printer can be used.

Cables

USB Cables

Figure 46 Micro,USB-A to USB-A

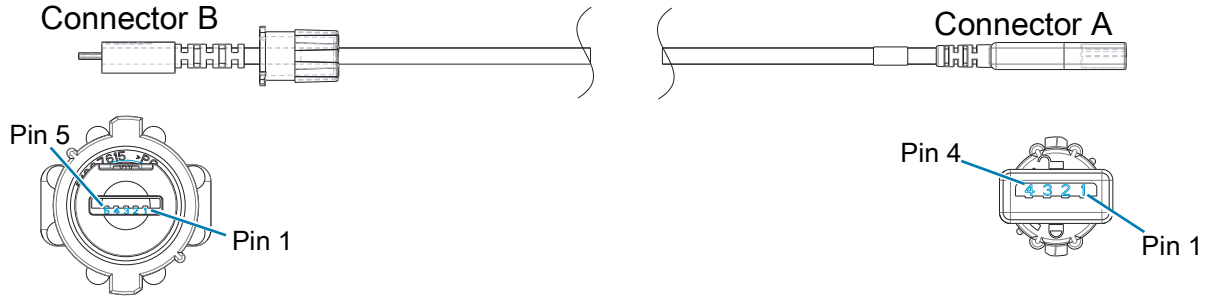

CONNECTOR B 5 POSITION USB MICRO TYPE A	SIGNAL	COLOR	CONNECTOR A 4 POSITION USB TYPE A RECEPTACLE
PIN 1	VBUS	RED	PIN 1
PIN 2	USB D-	WHITE	PIN 2
PIN 3	USB D+	GREEN	PIN 3
PIN 5	GROUND	BLACK	PIN 4

Figure 47 Micro USB-B to USB-A Plug, 1.8m/3.5m

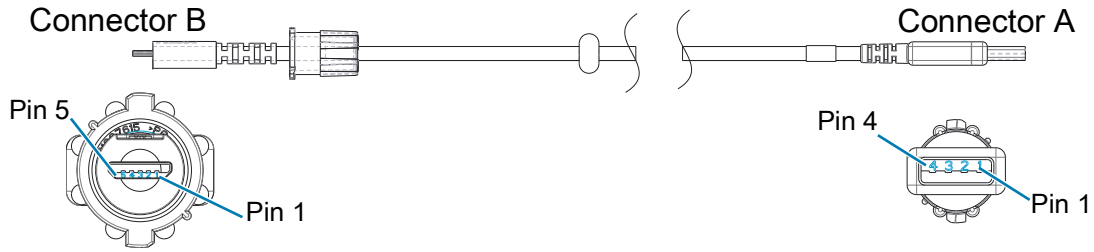

CONNECTOR B 5 POSITION USB MICRO TYPE B	SIGNAL	COLOR	CONNECTOR A 4 POSITION USB TYPE A PLUG
PIN 1	VBUS	RED	PIN 1
PIN 2	USB D-	WHITE	PIN 2
PIN 3	USB D+	GREEN	PIN 3
PIN 5	GROUND	BLACK	PIN 4



NOTE: Visit the Zebra website at: zebra.com/accessories for a listing of interface cables and part numbers for all Zebra mobile printers.

Media Supplies

To insure maximum printer life and consistent print quality and performance for your individual application, it is recommended that only media produced by Zebra be used.

Advantages include:

- Consistent quality and reliability of media products.
- Large range of stocked and standard formats.
- In-house custom format design service.
- Large production capacity which services the needs of many large and small media consumers including major retail chains world wide.
- Media products that meet or exceed industry standards.



NOTE: For more information go the Zebra website (zebra.com) and select the Products tab.

Maintenance Supplies

In addition to using quality media provided by Zebra, it is recommended that the printer be cleaned as prescribed in the maintenance section. The following item is available for this purpose:

- Cleaning Pen (12 pack): p/n 105950-035

Battery Disposal



The EPA certified RBRC® Battery Recycling Seal on the Lithium-Ion (Li-Ion) battery supplied with your printer indicates Zebra Technologies Corporation is voluntarily participating in an industry program to collect and recycle these batteries at the end of their useful life, when taken out of service in the United States or Canada. The RBRC program provides a convenient alternative to placing used Li-Ion batteries into the trash or the municipal waste stream, which may be illegal in your area.



IMPORTANT: When the battery is depleted, insulate the terminals with tape before disposal.

Please call 1-800-8-BATTERY for information on Li-Ion battery recycling and disposal bans/restrictions in your area.

Zebra Technologies Corporation's involvement in this program is part of our commitment to preserving our environment and conserving our natural resources.

Outside North America, please follow local battery recycling guidelines.

Product Disposal



The majority of this printer's components are recyclable. Do not dispose of any printer components in unsorted municipal waste. Please dispose of the battery according to your local regulations, and recycle the other printer components according to your local standards.

For more information, please see our web site at: zebra.com/environment.

Alert Messages

The printers display the following alert messages to inform the user of various fault conditions that might occur.

Message	Text Line One	Text Line Two
HeadOverTemp	PRINT HEAD OVERTEMP	PRINTING HALTED
HeadMaintenanceNeeded	HEAD MAINTEN. NEEDED	PRINTING HALTED
BatteryHelathReplace	BATTERY DIMINISHED	CONSIDER REPLACING
BatteryHealthNearDeath	WARNING - BATTERY	IS PAST USEFUL LIFE
BatteryHealthShutdown	BATTERY DIMINISHED	SHUTTING DOWN
BatteryAuthenticationFail	BATTERY FAILED	REPLACE BATTERY
BatteryOverTemp	CHARGING TEMP FAULT	MUST BE 0-40°C
BatteryUnderTemp	CHARGING TEMP FAULT	MUST BE 0-40°C
BatteryChargeFault	CHARGING FAULT	REPLACE BATTERY
DownloadingFirmware	DOWNLOADING	FIRMWARE
BadFirmwareDownload	DOWNLOAD FAILED	PLEASE REBOOT
WritingFirmwareToFlash	FIRMWARE	WRITING TO FLASH
Mirroring	LOOKING FOR UPDATES	PLEASE WAIT...
MirroringApplication	RECEIVING FIRMWARE	DO NOT POWER OFF!
MirroringCommands	MIRRORING COMMANDS	
MirroringFeedback	SENDING FEEDBACK	PLEASE WAIT...
MirrorProcessingFinished	MIRROR PROCESSING	FINISHED
WlanInvalidChannels	WIRELESS ERROR	INVALID CHANNEL
WlanInvalidSecurityMode	WIRELESS ERROR	INVALID SECURITY
PauseRequest	PRINTER PAUSED	
CancelAll	ALL JOBS CLEARED	
CancelOne	ONE JOB CLEARED	
OutOfMemoryStoringGraphic	OUT OF MEMORY	STORING GRAPHIC
OutOfMemoryStoringFont	OUT OF MEMORY	STORING FONT
OutOfMemoryStoringFormat	OUT OF MEMORY	STORING FORMAT
OutOfMemoryStoringBitmap	OUT OF MEMORY	STORING BITMAP
AckAlertTooManyUsbHostDevices	TOO MANY MASS	STORAGE DEVICES
AckAlertUnsupportedUsbHostDevice	UNSUPPORTED USB	HOST DEVICE
AckAlertUnsupportedUsbHost-Filesystem	UNSUPPORTED USB	HOST FILESYSTEM

